

DMG80480F070_02WN

产品概述:

- 基于 T5L0 芯片，运行 DGUS II 系统。
- 7.0 英寸，800*480 分辨率，262K 色，TN TFT 显示屏。
- 无触摸版本，产品厚度仅 3.5mm。
- COF 结构，智能屏的整个核心电路整合在液晶模组 FPC 上，适合结构要求轻、薄，成本要求苛刻，生产简单的应用。
- 排线共 50 个 pin 脚，引出用户 CPU 核的 IO、UART、CAN、AD、PWM 等接口，二次开发十分方便。

Features:

- Based on T5L0, running DGUS II system.
- 7.0-inch, 800*480 pixels resolution, 262K colors, TN TFT display.
- Smart screen without TP, product thickness of only 3.5 mm.
- COF structure. The entire core circuit of the smart screen is fixed on the FPC of LCM, featured by light and thin structure, low cost and easy production.
- 50 pins, including IO, UART, CAN, AD and PWM from user CPU core for easy secondary development.

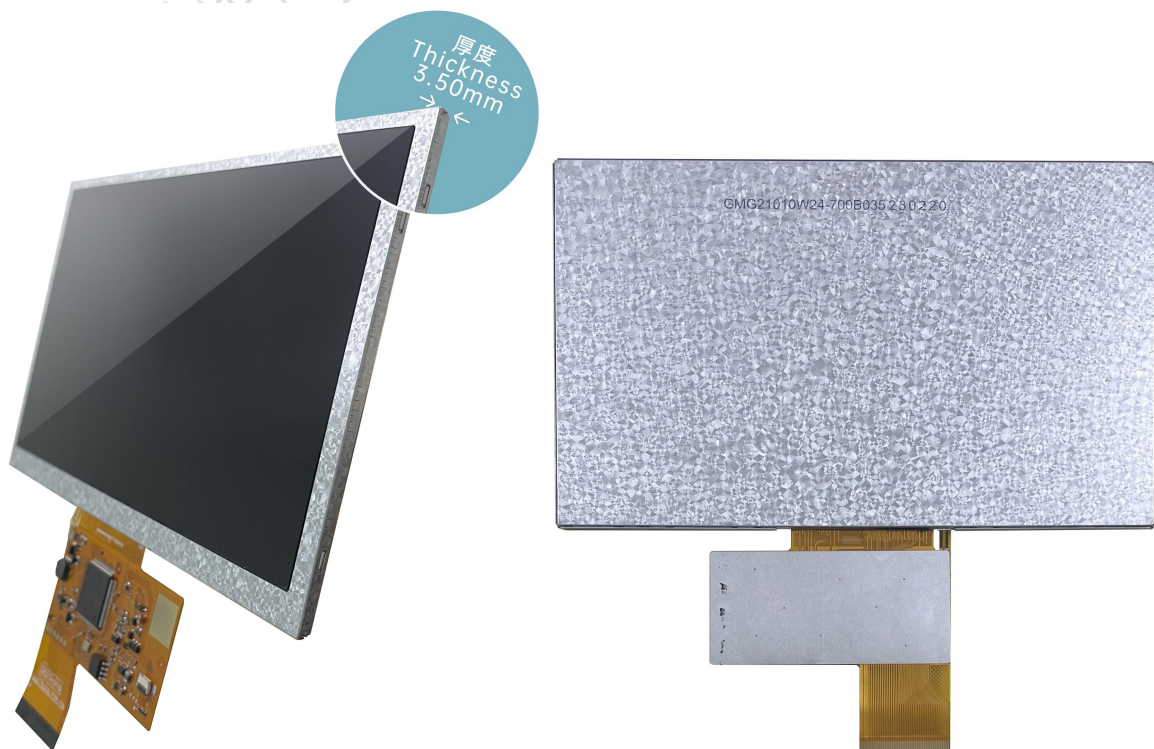

1 外部接口 External Interface



PIN 序号	Definition 定义	I/O	Functional Description 功能描述
1	+5V	I	供电输入，DC4.5-5.5V。 Power supply, DC4.5-5.5V.
2	+5V	I	
3	GND	GND	
4	GND	GND	
5	GND	GND	
6	AD7	I	5 路 ADC 输入，3.3V 电源做为参考，12bit 分辨率，输入电压范围 0-3.3V。除 AD6 外，其余数据通过 UART3 实时发送给 OS 核，采样速度为 16KHz。AD1 和 AD5 并联，AD3 和 AD7 并联使用，可以等效成两路 32KHz 采样 AD。AD1、AD3、AD5、AD7 并联在一起使用，可以等效成一路 64KHz 采样 AD；对数据做 1024 次累加后再除以 64，过采样获得 1 路 64Hz 16bit 的 AD 值。
7	AD6	I	
8	AD5	I	
9	AD3	I	
10	AD1	I	5 input ADCs. 12-bit resolution in case of 3.3V power supply. 0-3.3V input voltage. Except for AD6, the rest data is sent to OS core via UART3 in real time with 16KHz sampling rate. AD1 and AD5 can be used in parallel, and AD3 and AD7 can be used in parallel, which equals to two 32KHz sampling AD. AD1, AD3, AD5, AD7 can be used in parallel, which equals to a 64KHz sampling AD; the data is summed 1024 times and then divided by 64 to obtain a 64Hz 16bit AD value by oversampling.
11	+3.3	O	3.3V 输出，最大负载 150mA。 3.3V output, maximum load of 150mA.
12	SPK	O	外接 MOSFET 驱动蜂鸣器或扬声器，外部要 10K 下拉到 GND 确保上电是低电平。 External MOSFET to drive buzzer or speaker. The external 10K resistor should be pulled down to the ground to ensure that power-on is low level.
13	SD_CD	IO	SD/SDHC 接口，SD_CK 在靠近 SD 卡接口的地方对 GND 接一个 22pF 电容。 SD/SDHC interface, The SD_CK connects a 22pF capacitor to GND near the SD card interface.
14	SD_CK	O	
15	SD_D3	IO	
16	SD_D2	IO	
17	SD_D1	IO	
18	SD_D0	IO	
19	PWM0	O	2 路 16bit PWM 输出，外部要 10K 下拉到 GND 确保上电是低电平。 OS 核可以通过 UART3 来实时控制。
20	PWM1	O	2 16-bit PWM output. The external 10K resistor should be pulled down to the ground to ensure that power-on is low level. The OS core can be controlled in real time via UART3.
21	P3.3	IO	如果使用 RX8130 或 SD2058 I2C RTC，连接在这两个 IO 上。

22	P3.2	IO	SCL 接P3.2, SDA 接P3.3 并10K 上拉到3.3V。 If using RX8130 or SD2058 I2C RTC to connect to both IOs, SCL should be connected to P3.2, and SDA connected to P3.3 in parallel with 10K resistor pull-up to 3.3V.
23	P3.1/EX1	IO	可同时作为外部中断 1 输入, 支持低电平或下跳沿中断两种模式。 It can be used as an external interrupt 1 input at the same time, and supports both low voltage level or trailing edge interrupt modes.
24	P3.0/EX0	IO	可同时作为外部中断 0 输入, 支持低电平或下跳沿中断两种模式。 It can be used as an external interrupt 0 input at the same time, and supports both low voltage level or trailing edge interrupt modes.
25	P2.7	IO	IO □ IO interface
26	P2.6	IO	IO □ IO interface
27	P2.5	IO	IO □ IO interface
28	P2.4	IO	IO □ IO interface
29	P2.3	IO	IO □ IO interface
30	P2.2	IO	IO □ IO interface
31	P2.1	IO	IO □ IO interface
32	P2.0	IO	IO □ IO interface
33	P1.7	IO	IO □ IO interface
34	P1.6	IO	IO □ IO interface
35	P1.5	IO	IO □ IO interface
36	P1.4	IO	IO □ IO interface
37	P1.3	IO	IO □ IO interface
38	P1.2	IO	IO □ IO interface
39	P1.1	IO	IO □ IO interface
40	P1.0	IO	IO □ IO interface
41	UART4_TXD	O	串口 4 UART4
42	UART4_RXD	I	
43	UART5_TXD	O	串口 5 UART5
44	UART5_RXD	I	
45	P0.0	IO	IO □ IO interface
46	P0.1	IO	IO □ IO interface
47	CAN_TX	O	CANCAN 接口 (需外接 CAN 芯片驱动, 电路参考见 6-(7)) CAN interface (External CAN chip drive is required, refer to Figure 1. See 6 - (7) for circuit reference) 接口 CAN interface
48	CAN_RX	I	
49	UART2_TXD	O	串口 2 UART2 (OS 核的UART0 串口 UART0 serial port of OS core)
50	UART2_RXD	I	

2 规格参数 Specification Parameters

2.1 产品参数 Product Parameters

主控芯片 Main Chip	T5L0
用户接口方式 User Interface	50Pin_0.5mm FPC
FLASH	16M Bytes
UI 版本 UI Version	DGUSII / TA
供电方式 Power Supply	HDL662S 转接板供电 HDL662S adapter board power supply
显示色彩 Display Color	262K 色 262K colors
尺寸 Dimensions	7.0 英寸 7.0-inch
分辨率 Resolution	800*480
显示尺寸 (A.A) Active Area	154.08mm (W)×85.92mm (H)
可视角度 L/R/U/D Viewing Angle	TV 视角, 典型值 70° /70° /40° /30° (L/R/U/D) TV viewing angel, typical value of 70° /70° /40° /30° (L/R/U/D)
背光寿命 Backlight Service Life	>10000 小时 (以最高亮度连续工作, 亮度减半时间) > 10000 hours (Time of the brightness decaying to 50% on the condition of continuous working with the maximum brightness)
亮度 Brightness	250nit
背光调节 Brightness Control	100 级亮度调节 (当亮度调节至最高亮度的 1%~30%时, 可能出现闪烁现象, 不建议在此范围使用) 0~100 grade (When the brightness is adjusted to 1%~30% of the maximum brightness, flickering may occur and is not recommended to use in this range)

2.2 串口参数 Interface Parameters

参数 Item	测试条件 Conditions	最小值 Min	典型值 Typ	最大值 Max	单位 Unit
串口波特率 Baudrate	用户自定义（硬件配置文件设置） User Set(Configure the CFG file)	3150	115200	3225600	bps
串口输出电平 Output Voltage(TXD)	Output 1	3.0	3.3	-	V
	Output 0	-	0	0.3	V
串口输入电平 Input Voltage(RXD)	Input 1	-	-	3.3	V
	Input 0	0	-	0.5	V
串口模式 Interface	UART2: TTL; UART4: TTL; (OS 配置后才能使用 Only available after OS configuration) UART5: TTL; (OS 配置后才能使用 Only available after OS configuration)				
数据格式 Data Format	UART2: N81; UART4: N81/E81/O81/N82;四种模式可选 (OS 配置) 4 modes (OS configuration) UART5: N81/E81/O81/N82;四种模式可选 (OS 配置) 4 modes (OS configuration)				

2.3 电气规格 Electrical specifications

额定功率 Rated Power	<5W	
工作电压 Operating Voltage	4.5~5.5V, 典型值 5V 4.5~5.5V, typical value of 5V	
工作电流 Operating Current	440mA	VCC=5V, 背光亮度最大 VCC=5V, max backlight
	120mA	VCC=5V, 背光关闭 VCC=5V, backlight off
推荐工作电源: 5V 1A 的直流稳压电源 Recommended power supply: 5V 1A DC		

2.4 工作环境 Operating Environment

工作温度 Operating Temperature	-10℃~60℃ (5V @ 60% RH)
存储温度 Storage Temperature	-20℃~70℃
工作湿度 Operating Humidity	10%~90%RH, 典型值 60%RH 10%~90%RH, typical value of 60% RH

3 可靠性测试 Reliability Test

智能屏产品在量产前需根据实际应用需求及产品规格管控标准进行系列流程化可靠性检测，确保产品质量。

Before mass production of smart screens, a series of procedural reliability tests need to be conducted according to actual application requirements and product specification control standards to ensure product quality.

3.1 静电放电 ESD 测试 ESD Test

试验环境温度：25℃

Test temperature: 25℃

试验过程：将产品平置于测试台上，针对串口屏铁框周边和显示区域依次进行接触和空气放电，如下图 4.1 所示，实验过程观察屏幕是否出现死机、复位重启、黑屏、白屏、花屏、通信异常等工作异常现象。性能符合判据 GB/T 17626.2 B 级及以上。

Test process: the product was placed on the test bench to perform contact and air discharge in turn of the serial screen iron frame and display area as shown in Fig.4.1 below. During the experimental process, it was observed whether the screen is dead, black, white, splash, or reboot. According to the experiment results, the performance is in line with the criteria GB/T 17626.2 B level and above.



4.1 静电放电测试图

Electrostatic discharge test

放电类型 Discharge Type	放电值 Discharge Value	结果 Result
接触放电 Contact discharge	±4KV	正常工作 Normal operation
空气放电 Air discharge	±4KV	正常工作 Normal operation

3.2 高低温储存测试 High and Low Temperature Test

试验环境温度：-20~70℃

Test temperature:-20~70℃

试验过程：将产品斜置放在高低温测试箱内，测试时间 12H，进行 20 次开机、关机循环，自然恢复至常温后上电检查外观及功能，电容屏无偏移、跳点、乱跳和失效等问题。

Test process: the product will be placed obliquely in the high and low temperature test chamber for 12h for 20 on and off cycles. Then it will be check at room temperature after power on for the appearance and function, CTP offset situation, jumping point, page random switching and failure.

温度 Temperature	结果 Result
高温 High temperature (70℃)	正常工作 Normal operation
低温 Low temperature (-20℃)	正常工作 Normal operation

4 调试示例 Debug

建议首次使用迪文智能屏的用户购买测试套件。详细信息可联系客服人员。

It is recommended for new users of DWIN smart LCMs to purchase official accessories. For more details, please refer to customer service center.

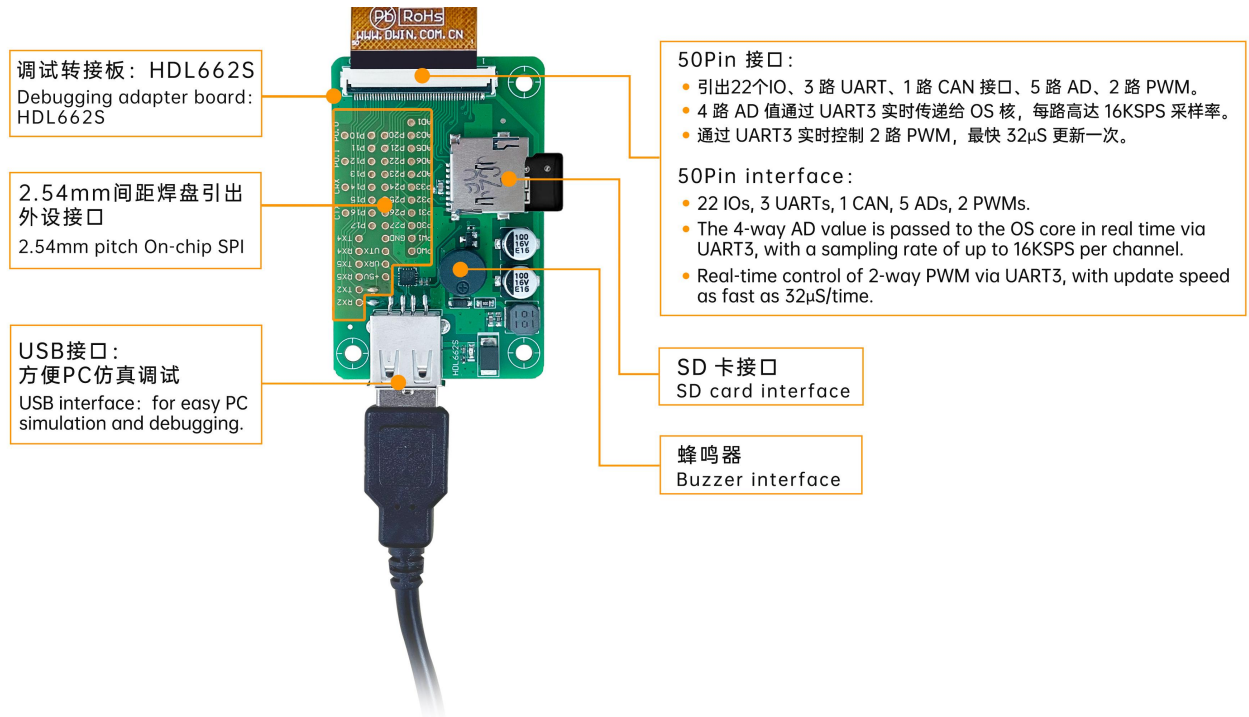

调试步骤：打开串口助手—自定义功能指令—设置指令—发送。

Operation steps: open serial assistant - custom function command - set command - send.

功能示例 For example:

(1) 调试切页 Page switching

Tx: 5AA5 07 82 0084 5A01 0008

(2) 待机设置 Standby backlight setting

Tx: 5AA5 07 82 0082 64 32 03E8

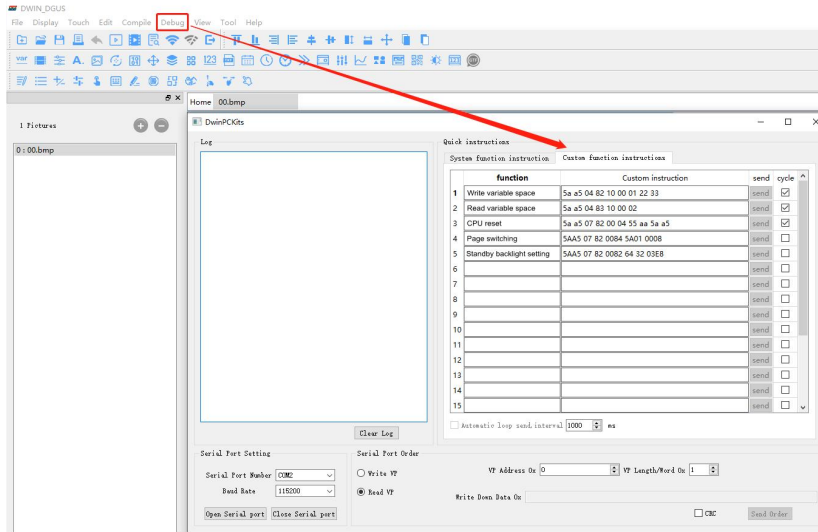

DGUS 操作图

DGUS operation

5 T5L0 主控芯片 T5L0 ASIC

T5L0 ASIC 是迪文科技针对小尺寸液晶应用显示而设计的低功耗、低成本、GUI 和应用高度整合的单芯片双核 ASIC，2020 年正式量产。

T5L0 ASIC is a low-power, cost-effective, GUI and application highly integrated single-chip dual-core ASIC designed by DWIN Technology for small-size LCD and mass produced in 2020.

- (1) 采用应用最广泛、成熟和稳定的 8051 核，1T（单指令周期）高速工作，最高主频 250MHz。

Mature and stable 8051 core which is the most widely used with the maximum operating frequency of T5L is up to 250MHz, 1T(single instruction cycle)high speed operation.

- (2) 单独 CPU 核（GUI CPU）运行 DGUS II 系统：

Separate GUI CPU core running DGUS II System:

- 内置高速显存，2.4GB/S 带宽，18bit 彩色显示分辨率支持到 1024*768（TA 模式），854*480（DGUS 模式）。
High-speed display memory, 2.4GB/S bandwidth. 18-bit color display resolution support up to 1024*768 (TA mode), 854*480 (DGUS mode).
- 2D 硬件加速，动画和图标为主的 UI 极其炫酷、流畅。
2D hardware acceleration and the UI with animation and icons as its main feature is extremely cool and smooth.
- JPEG 压缩模式存储图片、图标，大幅度缩小外置存储器到低成本的 16Mbytes SPI Flash。
Images and icons stored in JPEG format. Adopt Low-cost 16Mbytes SPI Flash.
- 高品质语音压缩存储和播放。
High quality ratio and sound restoration and playback.
- 128Kbytes 变量存储器空间，存储器接口和 OS CPU 核交换数据，应用简单。
128Kbytes variable storage space for exchanging data with OS CPU Core and memory.
- 2 路 10bit 800KHz DC/DC 控制器，简化 LED 背光、模拟电源设计并节约成本和空间。
2 10-bit 800KHz DC/DC controllers simplify LED backlight, analog power design and save cost and space.
- 支持 PC 端组态开发和仿真，支持后台远程升级。
Support DGUS development and simulation on PC. Support backend remote upgrade.

- (3) 单独 CPU 核（OS CPU）运行用户 8051 代码或迪文 DWIN OS 系统，应用中省掉用户 CPU：

Separate CPU (OS CPU) core runs user 8051 code or DWIN OS system and user CPU is omitted in practical application:

- 标准 8051 架构和指令集，64Kbytes 代码空间，32Kbytes 片内 RAM。
Standard 8051 core and instruction set, 64Kbytes code space, 32Kbytes on-chip RAM.
- 64bit 整数型数学运算单元（MDU），包括 64bit MAC 和 64bit 除法器。
64-bit integer mathematical operation unit (MDU), including 64-bit MAC and 64-bit divider.

- 内置软件 WDT, 3 个 16bit Timers, 12 路中断信号支持最高四级中断嵌套。
Built-in software WDT, 3 16-bit Timers, 12 interrupt signals support up to four levels of interrupt nesting.
 - 支持 IAP 在线仿真和调试, 断点数量无限制。
Support IAP online simulation and debugging with unlimited breakpoints.
 - 可以透过 DGUS 系统在线升级代码。
Upgrade code online through DGUS system.
- (4) 1Mbytes 片内 Flash, 迪文专利加密技术, 确保代码和数据安全, 杜绝山寨和克隆。
1Mbytes on-chip Flash with DWIN patent encryption technology ensure code and data security.
- (5) -40°C~+85°C工作温度范围 (可定制-55°C~105°C工作温度范围 IC)
Operating temperature ranges from -40°C to +85°C (IC operating temperature customizable from -55°C to 105°C).
- (6) 功耗低, 抗干扰能力强, 可以稳定工作在双面 PCB 设计上, 轻松通过 EMC/EMI 测试。
Low power consumption and strong anti-interference ability. It can work stably on double-sided PCB and passes EMC/EMI test easily.

6 COF 智能屏二次开发 COF Screen Secondary Development

标准的 8051 内核架构，方便采用 C 语言、汇编语言开发。

Standard 8051 core, easy to develop in C language and assembly language.

(1) 22 路 IO 口 22 IOs:

IO 口做为输出时，需要打开输出控制，输出强度及外设复用上电初始化配置后，IO 的后续使用和标准 8051 一致。C 语言开发代码示例：

To use output function of IO, you need to open the output control, output strength and peripheral multiplexing power-on initialization configuration. Subsequent use of IO is consistent with the standard 8051 as follows.

```
#include "sys.h"
sbit LED1 = P1^0;
sbit KEY1 = P1^1;
//IO 引脚初始化 Pin initialization
void io_init()
{
    PORTDRV = 0x01;//驱动电流为 8mA Driving current is 8mA
    P1MDOUT |= 0x01;//将 P1.0 设置为输出,用于驱动 LED1 灯 Set P1.0 as output to drive LED1 light
    P1MDOUT &= 0xFD;//将 P1.1 设置为输入,用于读取引脚的电平变化 Set P1.1 as input to read the voltage level change of the pin
}
void main(void)
{
    u16 cnt_1ms;
    u16 key1_sta;//存储 KEY1 引脚的电平状态 Store the voltage level state of the KEY1 pin
    sys_init();//系统初始化 System initialization
    io_init();//IO 引脚初始化 Pin initialization
    cnt_1ms = 0;
    key1_sta = KEY1;
    while(1)
    {
        cnt_1ms++;
        sys_delay_ms(1);//延时子函数，LED1 每隔 500ms 闪烁一次。 Delay sub-function, LED1 blinks every 500ms.
        if(cnt_1ms==500)
        {
            LED1 = !LED1;
            cnt_1ms = 0;
        }
        //KEY1 引脚的电平发生了变化,则更新到界面上 If the voltage level of the pin has changed, it will be updated in the interface
        if(key1_sta!=KEY1)
        {
            key1_sta = KEY1;
            sys_write_vp(0x1000,(u8*)&key1_sta,1);
        }
    }
}
```

```
    }  
  }  
}
```

(2) 3 路 UARTS 3 UARTs:

高速串口，最高支持 3225600bps，参考代码示例：

High-speed serial port, supporting up to 3225600bps, as follows.

```
#include "sys.h"  
#include "uart2.h"  
void main(void)  
{  
    u16 len;  
    sys_init();//系统初始化 System initialization  
    uart2_init(115200);//初始化串口 2 Initialize serial port 2  
    while(1)  
    {  
        if(uart2_rx_sta&UART2_PACKET_OK)//接受到了串口数据包 Received serial packet  
        {  
            len = uart2_rx_sta&UART2_PACKET_LEN;//得到串口数据包的长度,不包含"\r\n"或者'\n'结束符的长度 Get the length of  
the serial packet without "\r\n" or '\n' terminator  
            uart2_buf[len++] = 0;//在末尾添加 2 个空字符 Add 2 empty strings at the end  
            uart2_buf[len++] = 0;  
            printf("T5L_C51:%s\r\n",uart2_buf);//把接受到的数据包加上"T5L_C51:"前缀后返还给发送者 Return the received packet  
to the sender with the prefix "T5L_C51:"  
            sys_write_vp(0x2000,uart2_buf,len/2+1);//同时把数据包显示到界面上 At the same time display the packet to the  
interface  
            uart2_rx_sta = 0;//清 0 代表处理掉了此串口包 Reset means that this serial packet is disposed of  
        }  
    }  
}
```

(3) 1 路 CAN 1 CAN:

只需对 CAN 接口的特殊功能寄存器配置即可。参考代码示例：

Only the special function registers of the CAN need to be configured as follows.

```
void CanInit()  
{  
    P0MDOUT = 0x04;    //P0.2(CAN_TX)配置为输出 P0.2(CAN_TX) is configured as output  
    P0 = 0xFF;        //输出高电平 Output high voltage level  
    ADR_H = 0xFF;     //配置 DGUS 变量存储器地址 Configuring DGUS variable memory addresses  
    ADR_M = 0x00;  
    ADR_L = 0x60;  
    ADR_INC = 1;     //配置地址增量 Configure address increments  
    RAMMODE = 0x8F;  //写模式 Write mode  
}
```

```

while(!APP_ACK);      //等待确认,  Waiting for confirmation,
APP_ACK 硬件对 8051 占用变量存储器请求的应答, 1=OK, 0=BUSY, 需要继续等待。 Among answers of Hardware to 8051
occupied variable memory request, 1=OK and 0=BUSY, which need to continue to wait.
DATA3 = 0x1A;        //DGUS 变量存储器地址 0xFF:0060 赋值 Variable memory address 0xFF:0060 assignment
DATA2 = 0x17;
DATA1 = 0x0F;
DATA0 = 0;
APP_EN = 1;
while(APP_EN);      //等待数据操作完成, 操作完成后清零 Wait for the data operation to be completed, and reset after the
operation is completed
DATA3 = 0;          //验收寄存器 0xFF:0061 赋值清零 Acceptance register 0xFF:0061 assignment reset
DATA2 = 0;
DATA1 = 0;
DATA0 = 0;
APP_EN = 1;
while(APP_EN);      //等待数据操作完成, 操作完成后清零 Wait for the data operation to be completed, and reset after the
operation is completed
DATA3 = 0xFF;      //验收屏蔽寄存器 0xFF:0062 全部置 1, 不对接收进行验收 Acceptance Mask Register 0xFF:0062 all
set to 1, and no acceptance of reception
DATA2 = 0xFF;
DATA1 = 0xFF;
DATA0 = 0xFF;
APP_EN = 1;
while(APP_EN);      //等待数据操作完成, 操作完成后清零 Wait for the data operation to be completed, and reset after the
operation is completed
RAMMODE = 0;        //结束对 DGUS 变量存储器的访问 Terminate access to DGUS variable memory
CAN_CR = 0xA0;      //打开 CAN 接口, 并配置 FF0060-FF0062 Open CAN and configure FF0060-FF0062
while(CAN_CR&0x20); //执行配置 FF0060-FF0062 动作 Execute the configuration of FF0060-FF0062
ECAN = 1;           //打开 CAN 中断 Open the CAN interrupt
EA = 1;             //打开总中断 Open the total interrupt
}

```

(4) 5 路 A/D: 12bit, 支持采样到 16bit。

5 A/Ds: 12-bit, supports sampling to 16-bit

只需对 A/D 接口的特殊功能寄存器配置即可。参考代码示例:

Only the special function registers of the A/Ds need to be configured as follows.

```

#include "sys.h"
#include "adc.h"
void main(void)
{
    u16 ad;
    float vol;
    sys_init();//系统初始化 System initialization
    while(1)

```

```

{
    ad = adc_read_avg(ADC_CHANNEL0,10);//1.读取通道 0 的 ad 值 Read the ad value of channel 0
    vol = ad*(3300.0f/4095);//2.计算得到电压,单位 mV Calculate the voltage in mV
    sys_write_vp(0x2000,(u8*)&ad,1);//更新 ad 值 Update the ad value
    sys_write_vp(0x2001,(u8*)&vol,2);//更新电压值 Update the voltage value
}
}
    
```

(5) 2 路 PWM: 16bit 高精度分辨率可调。

2 PWMs: 16-bit high accuracy, adjustable resolution.

只需对 PWM 的频率、占空比进行配置即可。参考代码示例:

Only need to configure the frequency and duty cycle of PWM as follows.

```

void Pwm_0()
{
    u8 i=0;
    u8 temp[6]={0xAA,0x20,0x42,0x56,0x78,0};//配置 pwm_0 占空比 100%
    Write_Dgus(0x87,0x2042);//配置频率 100khz
    Write_Dgus(0x86,0x5A01);//
    for(i=0;i<5;i++) //校验和
        temp[5]+=temp[i];
    for(i=0;i<6;i++)//配置占空比
        OneSendData3(temp[i]);
}
    
```

(6) CAN 电路设计参考。

CAN circuit design parameters

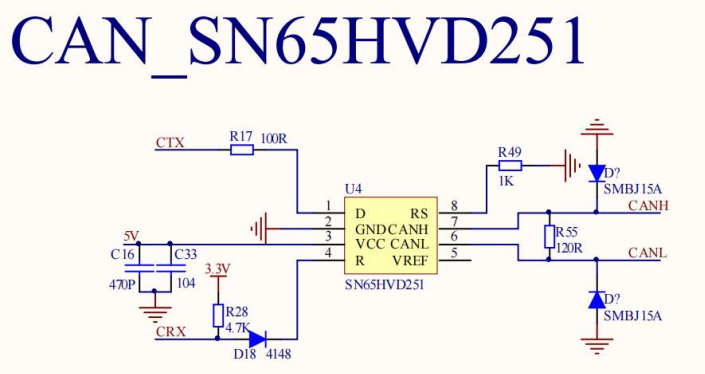

7 包装和物理尺寸 Packing Capacity & Dimension

尺寸 Dimension				
外形尺寸 Dimension	165.0(W) × 100.0 (H) × 3.5(T) mm			
净重量 Net Weight	110g			
包装标准 Packing Capacity				
包装箱型号 Model	包装箱尺寸 Size	层数(层) Layer	数量/层(片) Quantity/Layer	总数量(片) Quantity(Pcs)
纸箱 Carton:	410mm(L)×345mm(W)×165mm(H)	1	50	50

声明：产品设计改善或变更，不单独另行通知。

Disclaimer: The product design is subject to alternation and improvement without prior notice.

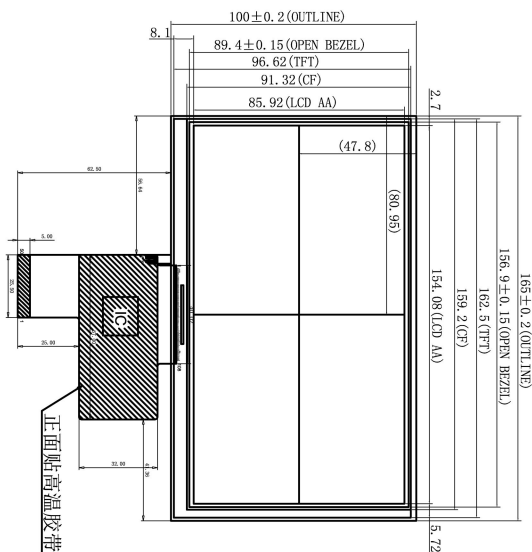

正视图

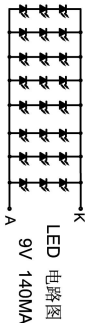

侧视图

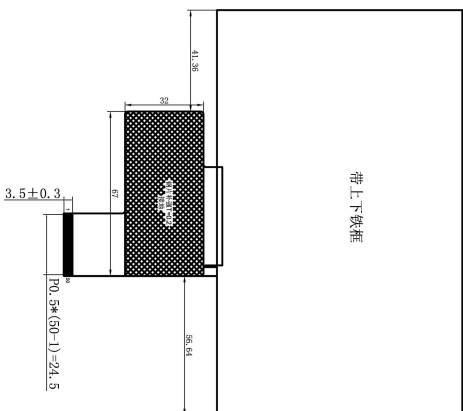

背视图

液晶屏PIN 定义

Pin#	Name	Pin#	Name
1	+5V	28	P26
2	+5V	27	P25
3	GND	28	P24
4	GND	29	P23
5	GND	30	P22
6	AD07	31	P21
7	AD08	32	P20
8	AD05	33	P17
9	AD03	34	P16
10	AD04	35	P18
11	AD02	36	P19
12	SPK	37	P13
13	SD_CD	38	P12
14	SD_CK	39	P11
15	SD_D3	40	P10
16	SDD2	41	TX4
17	SDD1	42	RX4
18	SDD0	43	TX5
19	FWM0	44	RX5
20	FWM1	45	P00
21	F23	46	P01
22	F22	47	P02
23	F21	48	P03
24	F20	49	P04
25	F21	50	TX2
26	F21	51	TX2

REVISION RECORD	VER	DATE	迪文科技有限公司	
1	Rev:1.0	2014.12.14	DESIGNER: SIMON	DESIGNER: SIMON
2	Rev:1.1	2015.04.01	DESIGNER: SIMON	DESIGNER: SIMON
3	Rev:1.2	2015.04.01	DESIGNER: SIMON	DESIGNER: SIMON
4	Rev:1.3	2015.04.01	DESIGNER: SIMON	DESIGNER: SIMON
5	Rev:1.4	2015.04.01	DESIGNER: SIMON	DESIGNER: SIMON
6	Rev:1.5	2015.04.01	DESIGNER: SIMON	DESIGNER: SIMON

REV. NO.	REV. DATE	REV. CONTENT	REV. BY
1	2014.12.14	Initial Release	Simon
2	2015.04.01	Change Pin 1 to +5V	Simon
3	2015.04.01	Change Pin 2 to +5V	Simon
4	2015.04.01	Change Pin 3 to GND	Simon
5	2015.04.01	Change Pin 4 to GND	Simon
6	2015.04.01	Change Pin 5 to GND	Simon

8 资料下载 Data Download

通过迪文官网 www.dwin.com.cn，下载相应的 DGUS 工具及产品规格书，或进入迪文开发者论坛查看视频教程、应用工程案例。更多了解，欢迎与我们联系：

You can download the corresponding DGUS tools and product specification, or go to DWIN Developer Forum to view video tutorials and application engineering cases through DWIN official website www.dwin.com.cn. For more information, please contact us at:

客服电话 Customer service Tel: 400 018 9008

客服 QQ Customer service QQ: 400 018 9008

客服邮箱 Customer service email: dwinhmi@dwin.com.cn

迪文开发者论坛 DWIN Developer Forum: <http://forum.dwin.com.cn>

感谢大家一直以来对迪文的支持，您的支持是我们进步的动力！谢谢大家！

Thank you all for continuous support of DWIN, and your approval is the driving force of our progress!

9 修订记录 Record of Revision

版本 Rev	日期 Date	描述 Content	编辑人 Editor
00	2023-03-14	首次发布 First Edition	郑运佳