

LI48272T043HA3098

4.3 inch, 480*272 pixels resolution, RGB interface, IPS-TFT-LCD



Disclaimer: The product design is subject to alternation and improvement without prior notice.

Table of Contents

| | |
|--|----|
| 1 General Feature..... | 3 |
| 2 Mechanical Drawing..... | 4 |
| 3 Input/Output Terminals..... | 5 |
| 4 Electrical Characteristics..... | 6 |
| 5 Timing Characteristics..... | 7 |
| 6 Optical Characteristics..... | 10 |
| 7 Environmental Reliability Test..... | 14 |
| 8 Packing Capacity & Dimension..... | 15 |
| 9 Appearance Inspection..... | 16 |
| 10 Precautions for Use of LCD Modules..... | 19 |
| 11 LCD Introduction..... | 20 |

1 General Feature

| Feature | | Description | Unit |
|----------------------------|---------------------|-----------------------------------|-------------------|
| Display Spec. | Size | 4.3 | inch |
| | Resolution | 480(H)*272(V) | pixels |
| | Pixel Configuration | RGB stripe | - |
| | Pixel Pitch | 0.066(H)*RGB*0.198(V) | mm |
| | Viewing Direction | ALL | - |
| Mechanical Characteristics | Outside Dimension | 105.40(W)*67.10(H)*2.95(D) | mm |
| | Active Area | 95.040(W)*53.856(H) | mm |
| | Luminance | 300 | cd/m ² |
| | LED Numbers | 8 LEDs | - |
| | Pin Order | From left to right 40PIN_0.5mm | - |
| | Weight | - | g |
| Electrical Characteristics | Interface | RGB_24bit | - |
| | Color Depth | 16.7M | colors |
| | Driver Condition | 3.3(Type) | V |
| | Driver IC | SC7283 | - |
| Temperature Range | Operating Temp. | -20~70 | °C |
| | Storage Temp. | -30~80 | °C |

Note: Requirements on Environmental Protection: RoHS.

You can use dynamic screen saver wallpapers to avoid afterimages caused by fixed paper display for a long time.

2 Mechanical Drawing

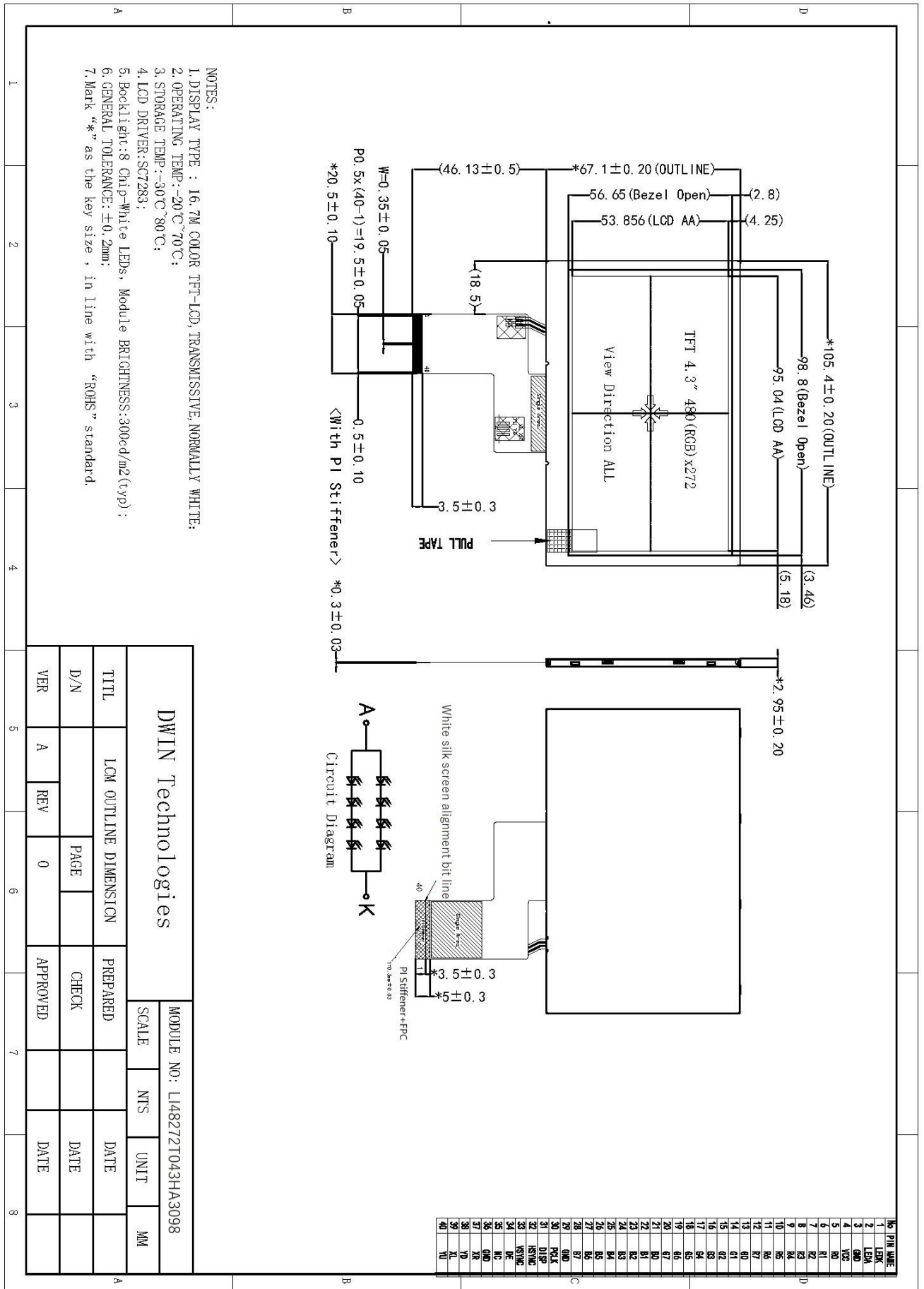

3 Input/Output Terminals

| Pin NO. | Symbol | Function | Remark |
|---------|--------|----------------------------------|--------|
| 1 | LEDK | Back light cathode | |
| 2 | LEDA | Back light anode | |
| 3 | GND | Ground | |
| 4 | VCC | Power supply | |
| 5-12 | R0-R7 | Data bus | |
| 13-20 | G0-G7 | Data bus | |
| 21-28 | B0-B7 | Data bus | |
| 29 | GND | Ground | |
| 30 | PCLK | Clock signal | |
| 31 | DISP | Display on/off | |
| 32 | HSYNC | Line synchronizing signal | |
| 33 | VSYNC | Frame synchronizing signal | |
| 34 | DE | Data ENABLE signal | |
| 35 | NC | Not connect | |
| 36 | GND | Ground | |
| 37 | XR(NC) | Touch panel X-right(no connect) | |
| 38 | YD(NC) | Touch panel Y-bottom(no connect) | |
| 39 | XL(NC) | Touch panel X-left(no connect) | |
| 40 | YU(NC) | Touch panel Y-up(no connect) | |

4 Electrical Characteristics

4.1 Driving TFT LCD Panel

| Item | Symbol | Min. | Typ. | Max. | Unit | Remark |
|---------------------------|--------|---------|------|---------|------|--------|
| Digital Voltage | VCC | 3.1 | 3.3 | 3.5 | V | |
| Gate Driver High Voltage | VGH | - | 14 | - | V | |
| Gate Driver Low Voltage | VGL | - | -11 | - | V | |
| Input Logic High Voltage | VIH | 0.7VCC | - | VCC | V | |
| Input Logic Low Voltage | VIL | GND | - | 0.3VCC | V | |
| Output Logic High Voltage | VOH | VCC-0.4 | - | VCC | V | |
| Output Logic Low Voltage | VOL | GND | - | GND+0.4 | V | |

4.2 LED Backlight Specification

| Item | Symbol | Min. | Typ. | Max. | Unit | Remark |
|----------------------|-----------|------|-------|------|-------------------|--------|
| Forward Voltage | V_F | 11.2 | 12 | 12.8 | V | |
| Forward Current | I_F | - | 40 | - | mA | |
| Luminance | L_V | - | 300 | - | cd/m ² | |
| Power Consumption | P_{LED} | - | 480 | - | mW | |
| Uniformity(with L/G) | Avg | 75 | 80 | - | % | |
| LED Life-Time | Hr | - | 30000 | - | Hour | |

Note: 8 LEDs (4 LEDs Serial,2 ways Parallel)



5 Timing Characteristics

5.1 Parallel 24-bit RGB Timing Table

| 480RGB X 272 Resolution Timing Table | | | | | | | |
|--------------------------------------|----------------|--------|------|------|------|--------|-----------------------|
| Item | Symbol | Min. | Typ. | Max. | Unit | Remark | |
| DCLK Frequency | Fclk | 8 | 9 | 12 | MHz | | |
| DCLK Period | Tclk | 125 | 111 | 83 | ns | | |
| HSYNC | Period Time | Th | 487 | 531 | 598 | DCLK | |
| | Display Period | Thdisp | - | 480 | - | DCLK | |
| | Back Porch | Thbp | 3 | 43 | 43 | DCLK | By H_Blanking setting |
| | Front Porch | Thfp | 4 | 8 | 75 | DCLK | |
| | Pulse Width | Thw | 2 | 4 | 75 | DCLK | |
| VSYNC | Period Time | Tv | 276 | 292 | 321 | H | |
| | Display Period | Tvdisp | - | 272 | - | H | |
| | Back Porch | Tvbp | 2 | 12 | 12 | H | By V_Blanking setting |
| | Front Porch | Tvfp | 2 | 8 | 37 | H | |
| | Pulse Width | Tvw | 2 | 4 | 37 | H | |

5.2 SYNC Mode Timing Diagram

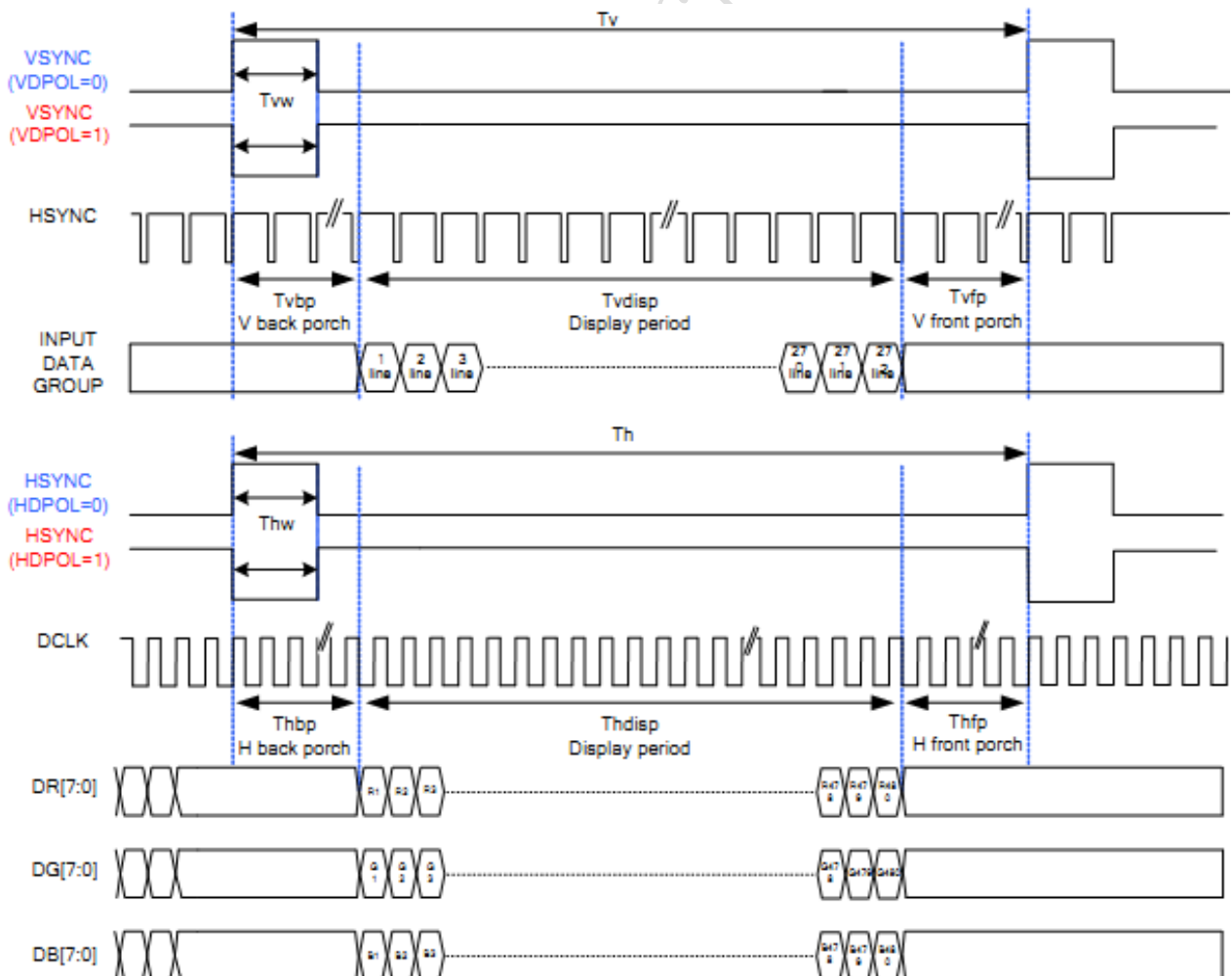

5.3 SYNC-DE Mode Timing Diagram

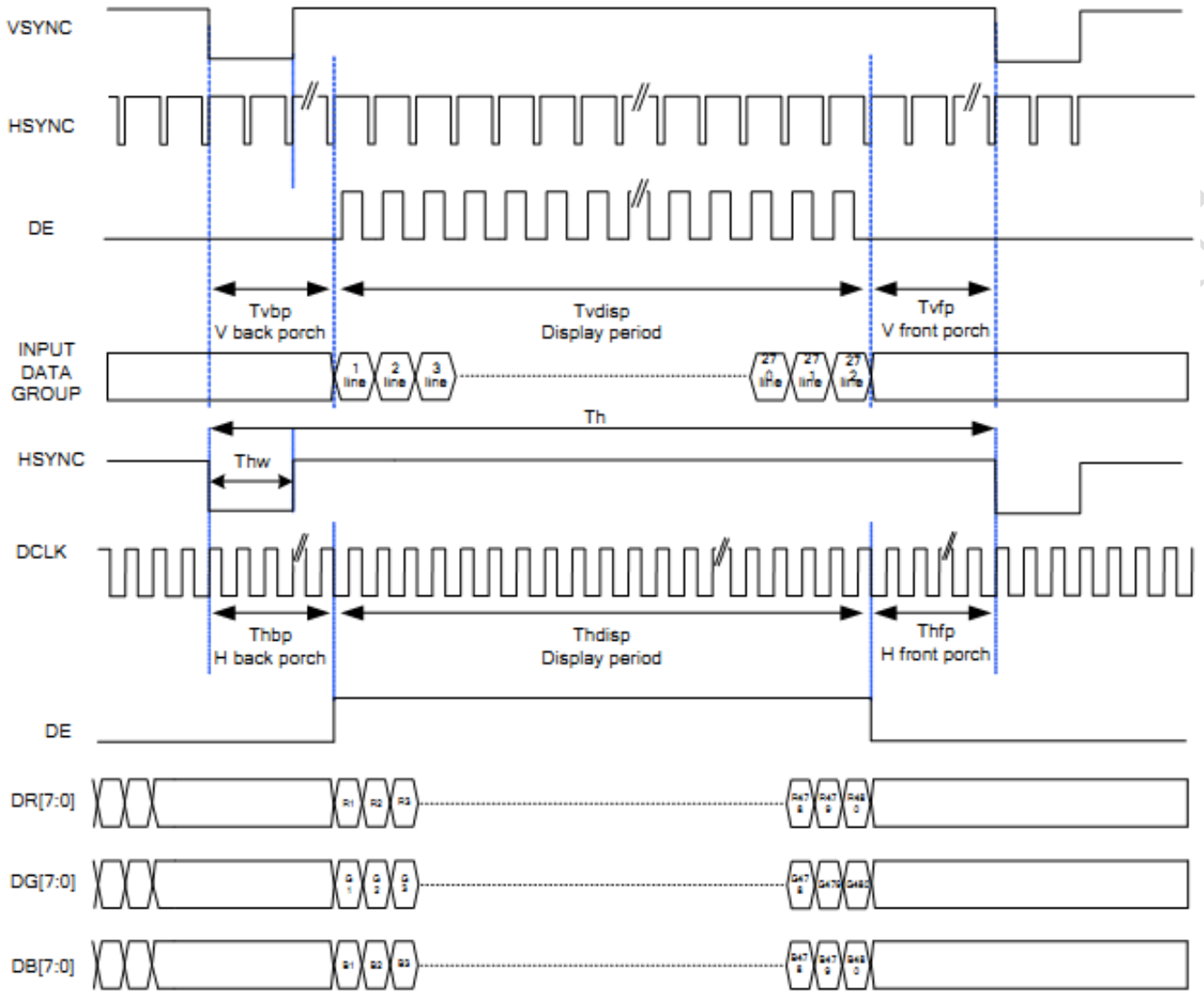

5.4 DE Mode Timing Diagram

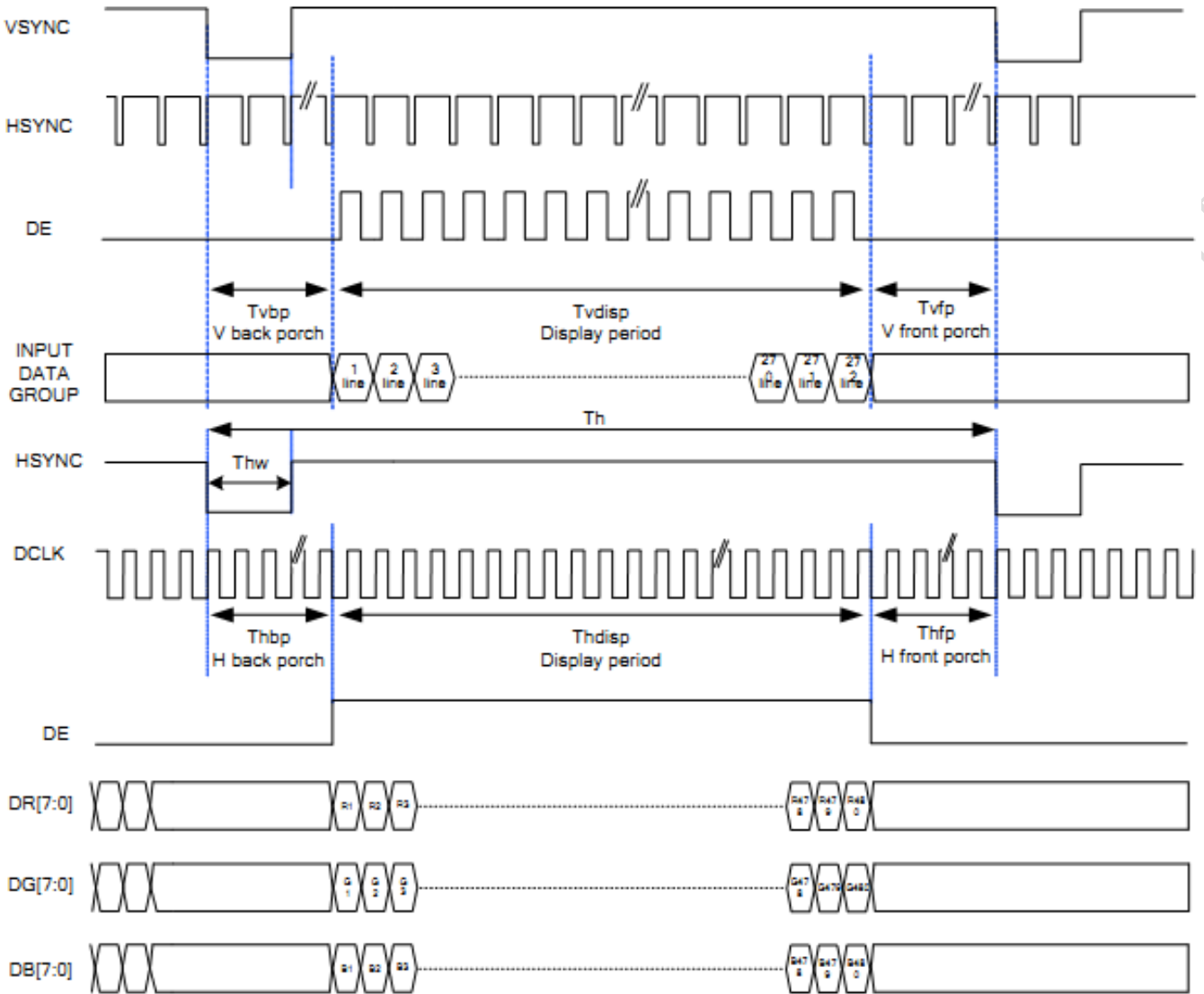

5.5 Power On/Off Sequence

Power On Sequence:

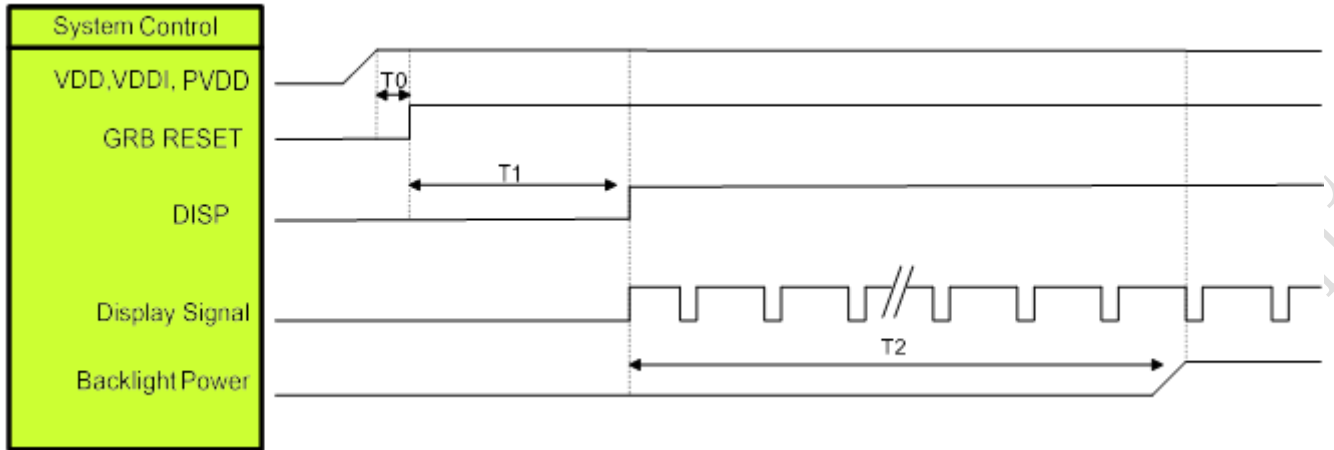

| Symbol | Description | Min. Time | Unit |
|--------|---|-----------|------|
| T0 | System power stability to GRB RESET signal | 0 | ms |
| T1 | GRB RESET= "High" to DISP="High" | 10 | ms |
| T2 | Display Signal output to Backlight Power on | 250 | ms |

Power Off Sequence:

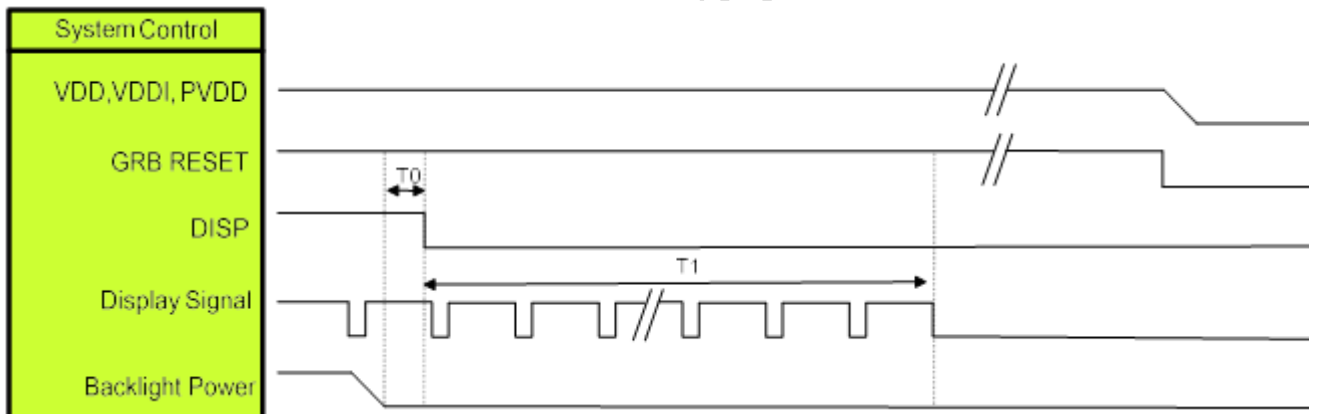

| Symbol | Description | Min. Time | Unit |
|--------|--|-----------|------|
| T0 | Backlight Power off to DISP="Low" | 5 | ms |
| T1 | DISP="Low" to IC internal voltage discharge complete | 80 | ms |

6 Optical Characteristics

| Item | Symbol | Condition | Min. | Typ. | Max. | Unit | Remark |
|---------------------------------|-----------|------------------|-------|-------|-------|------|--------|
| Viewing Angle | Top | $CR \geq 10$ | - | 85 | - | Deg. | Note 2 |
| | Bottom | | - | 85 | - | | |
| | Left | | - | 85 | - | | |
| | Right | | - | 85 | - | | |
| Contrast Ratio | CR | $\theta=0^\circ$ | 640 | 800 | - | | |
| Response Time | T_r+T_f | $\theta=0^\circ$ | - | 30 | 40 | ms | |
| Color Chromaticity (CIE1931) | Wx | $\theta=0^\circ$ | 0.300 | 0.320 | 0.340 | | |
| | Wy | | 0.325 | 0.345 | 0.365 | | |
| | Rx | | 0.609 | 0.629 | 0.649 | | |
| | Ry | | 0.306 | 0.326 | 0.346 | | |
| | Gx | | 0.317 | 0.337 | 0.357 | | |
| | Gy | | 0.526 | 0.546 | 0.546 | | |
| | Bx | | 0.116 | 0.136 | 0.156 | | |
| | By | | 0.123 | 0.143 | 0.163 | | |
| Transmittance (w/o DBEF) | T% | $\theta=0^\circ$ | 6.2 | 6.9 | - | % | |

Test conditions:

IF= 40 mA, and the ambient temperature is 25°C.

Note 1: Definition of optical measurement system.

The optical characteristics should be measured in dark room. After 5 minutes operation, the optical properties are measured at the center point of LCD.

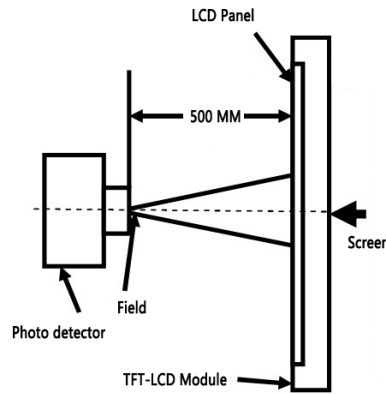
Note 2: Definition of viewing angle range and measurement system.

The viewing angle is measured at the center point of the LCD by BM-7A.

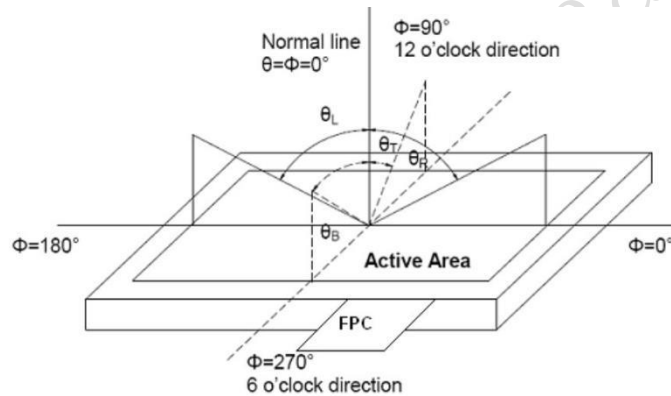
Note 3: Definition of color temperature.

When the radiation of the light source is exactly the same in the visible region and the absolute blackbody, the temperature of the blackbody is called the color temperature of the light source. Color temperature is an index to measure the degree of light source color (cold color, warm color). Warm color < 3300K, intermediate color 3300 ~ 5000K, cold color > 5000K.

Note 4: Definition of response time.

The response time is defined as the LCD optical switching time interval between “White” state and “Black” state. Time ON (TON) is the time between photo detector output intensity changed from 90% to 10%. And time off (TOFF) is the time between photo detector output intensity changed from 10% to 90%.

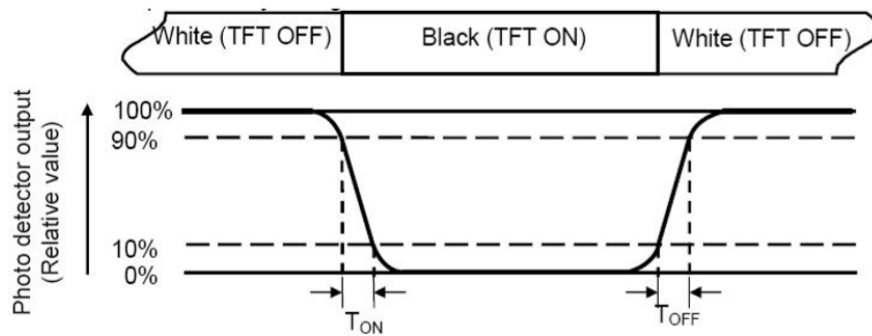
**Note 5: Definition of color chromaticity (CIE1931).**

Color coordinates measured at center point of LCD.

Note 6: Definition of luminance.

Measure the luminance of white state at center point.

7 Environmental Reliability Test

| NO | Test Item | Condition | Remarks |
|----|--|---|--|
| 1 | High Temperature Operation | Ta=+70°C,48hours | IEC60068-2-1:2007 GB2423.2-2008 |
| 2 | Low Temperature Operation | Ta=-20°C,48hours | IEC60068-2-1:2007 GB2423.1-2008 |
| 3 | High Temperature Storage | Ta=+80°C,48hours | IEC60068-2-1:2007 GB2423.2-2008 |
| 4 | Low Temperature Storage | Ta=-30°C,48hours | IEC60068-2-1:2007 GB2423.1-2008 |
| 5 | Storage at High Temperature and Humidity | Ta=+60°C,90% RH max,48hours | IEC60068-2-78 :2001 GB/T2423.3-2006 |
| 6 | Thermal Shock (non-operation) | -30°C /30min~ +80°C/30min, Change time:5min,10cycles | Start with cold temperature, End with high temperature, IEC60068-2-14:1984, GB 2423.22-2002 |

8 Packing Capacity & Dimension

| Dimension | | | |
|----------------------------|----------------------------|-------|---------------|
| Dimension(mm) | 105.40(W)*67.10(H)*2.95(D) | | |
| Net Weight | - | | |
| Packing Capacity | | | |
| Size | LCD Size and Resolution | Layer | Quantity(Pcs) |
| 220mm(L)x160mm(W)x47mm(H) | 4.3 inch 480*272 | 1 | 1 |
| 600mm(L)x450mm(W)x300mm(H) | 4.3 inch 480*272 | 2 | 240 |

Packing instruction:

The LCD is placed in the grid, covered with a PE static bag and compactly assembled, the upper and the lower layers of the grid are protected by buffer spaces.

The LCD covered with a PE static bag and compactly assembled



placed in the grid



The upper and the lower layers of the grid are protected by buffer spaces



Packed



9 Appearance Inspection

9.1 General rules for inspection

9.1.1 Anti-static wearables (anti-static wristbands, gloves) must be worn during the inspection.

9.1.2 Do not use bare hands to touch the position of the device, golden fingers, and the surface of the screen to prevent the sweat from human hands from causing oxidation and affecting the appearance.

9.1.3 It is forbidden to stack products out of specification and handle them with care to avoid damage to components.

9.1.4 The repaired products need to be inspected to prevent rosin and tin slag from exceeding the specifications.

9.1.5 When technical documents and process documents have specific requirements for products, the technical documents and process documents shall be the main requirements.

9.2 Inspection conditions

9.2.1 The conditions of display function check

Angle: $\pm 5^\circ$;

Inspection method: visual inspection. The inspection object is 30-40cm away from the light source, and the eye is 30-40cm away from the inspection object;

Illumination: 300-500Lux;

Inspection time: 5-10S.

9.2.2 Visual inspection conditions

Angle: $\pm 45^\circ$;

Inspection method: visual inspection. The inspection object is 30-40cm away from the light source, and the eye is 30-40cm away from the inspection object;

Illumination: 800-1500Lux;

Inspection time: 5-10S.

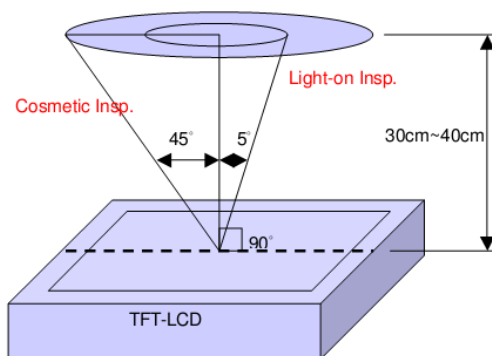

9.3 Inspection standards

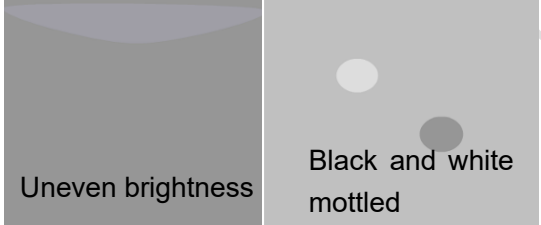
| Type | Test Items | Judgement Standard | Defect Category |
|----------------|---------------------------|--|-----------------|
| Display state | Dead pixels | No dead pixels | |
| | mura | <p>From different angles, the brightness is required to be uniform. Under the 64-level grayscale or pure black interface, there should be no uneven display brightness within the viewing angle range of 45° through 6% ND FILTER. Y series (TV film) LCD screen does not have specific requirements, and the picture inspection does not affect the display as qualified.</p>  | Slight defect |
| | Light leakage | <p>Under the 64-level grayscale or pure black interface, there should be no obvious light leakage within the viewing angle range of 45° by visual inspection or through 6% ND FILTER. Y series (TV LCD screen) series can be without obvious visual defects.</p> | Slight defect |
| | Linear foreign bodies | <p>1. $W \leq 0.05$, $L \leq 2\text{mm}$, negligible; 2. $0.05\text{mm} < W \leq 0.1\text{mm}$, $L \leq 2\text{mm}$, $N \leq 3$; 3. $W > 0.1\text{mm}$, $L > 2\text{mm}$, not allowed.</p> | Slight defect |
| Screen surface | Within the effective area | <p>Spotted: 1. $D \leq 0.2\text{mm}$ and it is not a piece, it is not counted; 2. $0.2\text{mm} < D \leq 0.5\text{mm}$, $N \leq 3$; 3. $D > 0.5\text{mm}$, $L > 0.5\text{mm}$, $W > 0.5\text{mm}$ are not allowed; (The spotted foreign objects shall not exceed the point-line gauge $D=0.5$, and the black dot coverage shall be checked, and the spotted foreign objects shall be judged within the range of $D=0.5$)</p> | Slight defect |

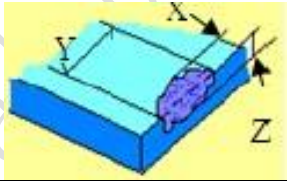
| | | | |
|-----|---|---|---|
| | Foreign objects Scratch Air bubbles | Linear: 1. $W \leq 0.05$, $L \leq 2\text{mm}$, ignored; 2. $0.05 < W \leq 0.1\text{mm}$, $L \leq 2\text{mm}$, $N \leq 3$; 3. $W > 0.1\text{mm}$, $L > 2\text{mm}$, not allowed. | |
| | Outside the effective area Foreign objects Scratches Air bubbles | Foreign objects are not checked, and bubbles are not allowed to $D > 1\text{mm}$; Non-inductive scratches of no more than $0.1 \times 8\text{mm}$ are allowed. | Slight defect |
| | Crack | Not allowed. |  Slight defect |
| | Notch | 1. Does not affect the appearance from the front; 2. Does not affect the relevant alignment; 3. $X \leq 1\text{mm}$, $Y \leq 1\text{mm}$, $N \leq 2$. |  Slight defect |
| | Glass side Foreign objects Dirty | 1. The foreign body on the side is not controlled; 2. The paint pen marks on the side are not controlled; 3. Side oily note printing is not allowed. | Slight defect |
| FPC | Cracks Goldfinger crease | Not allowed. | Heavy deficit |
| | Crease | Slight creases are not controlled; The crease is whitish and has lines, which is not allowed. | Heavy deficit |
| | Top wound, stab wound | No damage to the line, $D \leq 0.2\text{mm}$; Damage to the line is not allowed. | Heavy deficit |
| | Scratch | Slight scratches on the surface are not controlled; Damage to the line is not allowed. | Heavy deficit |
| | Goldfinger scratch | $W \leq 0.05\text{mm}$, no control; $W > 0.05\text{mm}$, not allowed; Test probe tip marks are not controlled. | Heavy deficit |
| | Component | Under-soldering, over-soldering and false soldering are not allowed. | Heavy deficit |

10 Precautions for Use of LCD Modules

10.1 Handling Precautions

10.1.1 The display panel is made of glass. Do not subject it to a mechanical shock by dropping it from a high place, etc.

10.1.2 If the display panel is damaged and the liquid crystal substance inside it leaks out, be sure not to get any in your mouth, if the substance comes into contact with your skin or clothes, promptly wash it off using soap and water.

10.1.3 Do not apply excessive force to the display surface or the adjoining areas since this may cause the color tone to vary.

10.1.4 The polarizer covering the display surface of the LCD module is soft and easily scratched. Handle this polarizer carefully.

10.1.5 If the display surface is contaminated, breathe on the surface and gently wipe it with a soft dry cloth. If still not completely clear, Can only use LCD dedicated cleaner, the following organic solvent can not be used:

- Isopropyl alcohol
- Ethyl alcohol
- Ketone
- Aromatic solvents

10.1.6 Do not attempt to disassemble the LCD Module.

10.1.7 If the logic circuit power is off, do not apply the input signals.

10.1.8 To prevent destruction of the elements by static electricity, be careful to maintain an

10.1.9 optimum work environment.

10.1.9.1 Be sure to ground the body when handling the LCD Modules.

10.1.9.2 Tools required for assembly, such as soldering irons, must be properly ground.

10.1.9.3 To reduce the amount of static electricity generated, do not conduct assembly and other work under dry conditions.

10.1.9.4 The LCD Module is coated with a film to protect the display surface. Be care when peeling off this protective film since static electricity may be generated.

10.2 Storage precautions

10.2.1 When storing the LCD modules, avoid exposure to direct sunlight or to the light of fluorescent lamps.

10.2.2 The LCD modules should be stored under the storage temperature range. If the LCD modules will be stored for a long time, the recommend condition is:

Temperature: 0°C ~ 40°C Relatively humidity: ≤80%.

10.2.3 The LCD modules should be stored in the room without acid, alkali and harmful gas.

10.3 Transportation Precautions

10.3.1 The LCD modules should be no falling and violent shocking during transportation, and also should avoid excessive press, water, damp and sunshine.

11 LCD Introduction

11.1 Process capacity

DWIN adopts original class A glass and the entire production is in the park from cleaning, cutting, bonding, and laminating of large glass to backlight assembly, quality inspection, and aging.

There are 12,000 square meters of clean workshop, with a monthly production capacity of about 2.5 million pieces. Each piece of LCD produced in the factory is for 30 days of aging.



11.2 ODM service

Based on LCD products of 1.5~21.5 inches, DWIN provides the following customization services.

1、LCD HDMI interface customization.

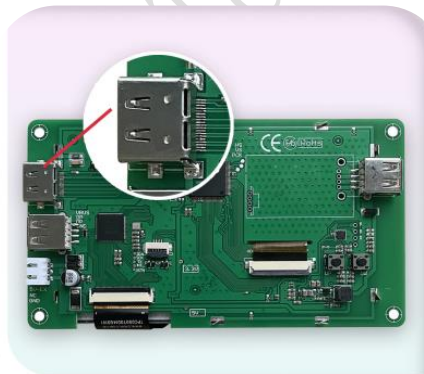

HDMI interface

2、Special screen customization such as high brightness, ultra-wide temperature and strong electromagnetic protection.

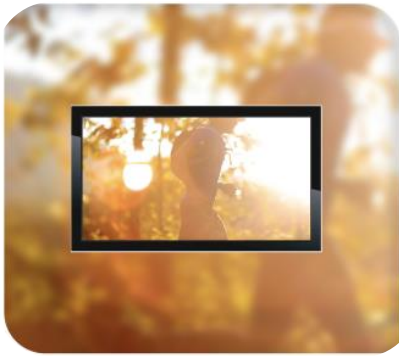

High luminance
(up to 1200nit)



Ultra-wide temperature
(-40~85℃)



Strong electromagnetic
protection

3、Lamination customization service of LCD + TP.



LCM+RTP



LCM+CTP

4、Customization service of DWIN self-developed T5L ASIC+ LCD + TP.



5、Smart screen finished product customization.

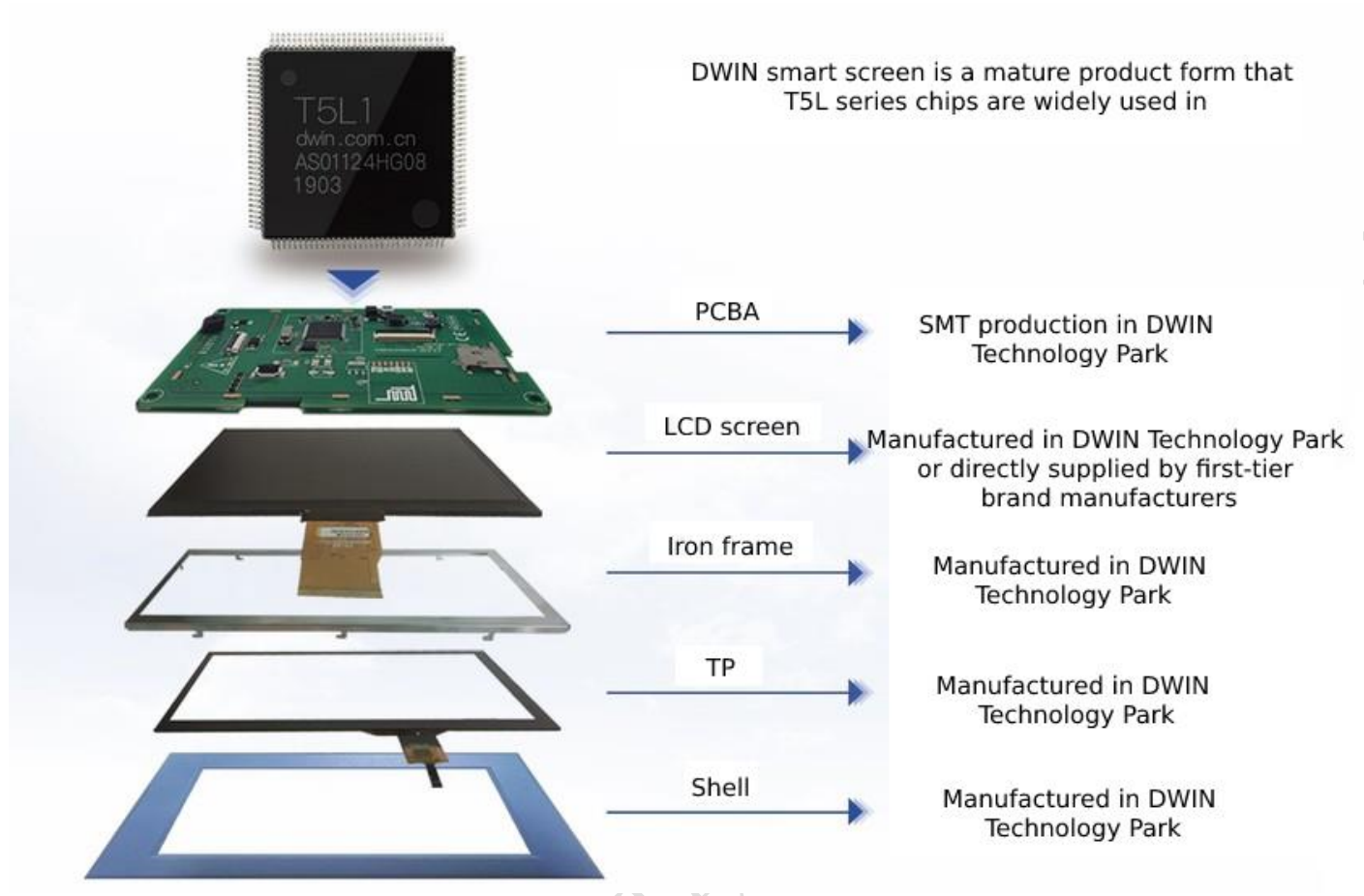

Please contact our sales staff for other customization needs.

Record of Revision

| Rev | Date | Description | Editor |
|-----|------------|-----------------------------------|----------------|
| 00 | 2020-11-16 | First Release | Zhou Biao |
| 01 | 2021-04-23 | Increase LED Life | Yang Zehua |
| 02 | 2021-07-07 | Update the Definition | Ouyang Kaixing |
| 03 | 2021-08-06 | Update the Timing Characteristics | Ouyang Kaixing |
| 04 | 2022-01-24 | Update the General Feature | Ouyang Kaixing |
| 05 | 2022-12-19 | Add Product Picture | Chen Xian |
| 06 | 2023-02-22 | Update Packing Capacity | Chen Xian |
| 07 | 2023-05-11 | Update Terminals | Chen Xian |

Please contact us if you have any questions about the use of this document or our products, or if you would like to know the latest information about our products:

Customer service tel: +86 400 018 9008

Customer service email: dwinhmi@dwin.com.cn

DWIN developer forum: <https://forums.dwin-global.com/index.php/forums/>

Thank you all for continuous support of DWIN, and your approval is the driving force of our progress!