



## **LN48272T043IB3598-TCF**

4.3 inch, 480×272, TN screen with normal viewing angle, air bonding CTP

DWIN Technology Technical Document

Disclaimer: The product design is subject to alternation and improvement without prior notice.

## Table of Contents

1 General Feature.....	3
2 Mechanical Drawing.....	5
3 Input/Output Terminals.....	6
4 Electrical Characteristics.....	7
5 Timing Characteristics .....	8
6 Optical Characteristics.....	11
7 Environmental Reliability Test .....	14
8 Packing Capacity & Dimension .....	15
9 Appearance Inspection .....	16
10 Precautions for Use of LCD Modules .....	19
11 Laminated Screen Introduction .....	20

# 1 General Feature

## 1.1 LCD Parameters

Feature		Description	Unit
Display Spec.	Size	4.3	inch
	Resolution	480(H)*272(V)	pixels
	Pixel Configuration	RGB stripe	-
	Pixel Pitch	0.198(H)*0.198(V)	mm
	Viewing Direction	6 o'clock	-
Mechanical Characteristics	Outside Dimension	105.40(W)*67.10(H)*2.95(D)	mm
	Active Area	95.040(W)*53.856(H)	mm
	Luminance	250	cd/m <sup>2</sup>
	LED Numbers	8 LEDS	-
	Pin Order	From left to right 40PIN_0.5mm	-
Electrical Characteristics	Interface	RGB_24bit	-
	Color Depth	16.7M	colors
	Driver Condition	3.3(Type)	V
	LCM Driver IC	NV3047	-
Temperature Range	Operating Temp.	-20~70	°C
	Storage Temp.	-30~80	°C

## 1.2 Touch Parameters

Feature	Description
Type	CTP (Capacitive touch panel)
Structure	G+G
Outline Size(mm)	105.2(L)*67.0(W)*1.6(T)
View Area(mm)	96.54(L)*55.36(W)
Control Type	GT911
Surface Hardness	6H
Light Transmittance	≥85%
Operating Temperature	-20~70℃
Storage Temperature	-20~70℃

**Note: Requirements on Environmental Protection: RoHS**

## 2 Mechanical Drawing

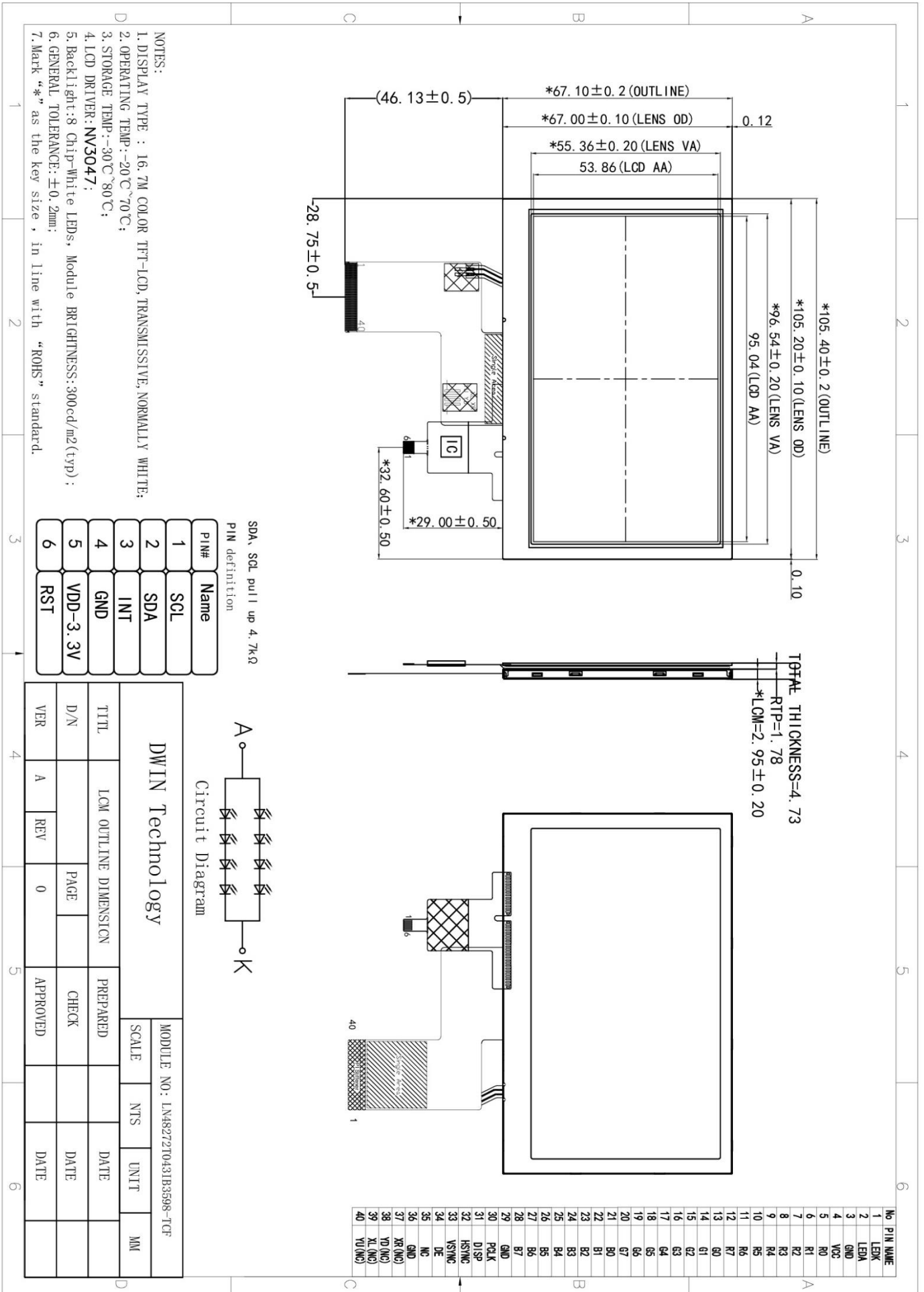

### 3 Input/Output Terminals

#### 3.1 LCD Input/Output Terminals

Pin NO.	Symbol	Function	Remark
1	LEDK	Back light cathode	
2	LEDA	Back light anode	
3	GND	Ground	
4	VCC	Power supply	
5-12	R0-R7	Data bus	
13-20	G0-G7	Data bus	
21-28	B0-B7	Data bus	
29	GND	Ground	
30	PCLK	Clock signal	
31	DISP	Display on/off	
32	HSYNC	Line synchronizing signal	
33	VSYNC	Frame synchronizing signal	
34	DE	Data ENABLE signal	
35	NC	Not connect	
36	GND	Ground	
37	XR	touch panel X-right(Not connect)	
38	YD	touch panel Y-bottom(Not connect)	
39	XL	touch panel X-left(Not connect)	
40	YU	touch panel Y-up(Not connect)	

#### 3.2 TP Input/Output Terminals

Pin NO.	Logic	Remark
1	SCL	
2	SDA	
3	INT	
4	GND	
5	VDD-3.3V	
6	RST	

## 4 Electrical Characteristics

### 4.1 Driving TFT LCD Panel

Item	Symbol	Min.	Typ.	Max.	Unit	Remark
Analog Voltage	VCC	3.1	3.3	3.5	V	
Input Logic High Voltage	VIH	0.7VCC	-	VCC	V	
Input Logic Low Voltage	VIL	GND	-	0.3VCC	V	
Output Logic High Voltage	VOH	VCC-0.4	-	VCC	V	
Output Logic Low voltage	VOL	GND	-	GND+0.4	V	

### 4.2 LED Backlight Specification

Item	Symbol	Min.	Typ.	Max.	Unit	Remark
Forward Voltage	$V_F$	11.2	12.0	12.8	V	
Forward Current	$I_F$	-	40	-	mA	
Luminance	$L_v$	-	250	-	cd/m <sup>2</sup>	
Uniformity(with L/G)	YU	75	80	-	%	
LED Life-Time	Hr	-	30000	-	Hour	

Note: 8 LEDs (4 LEDs Serial, 2 ways Parallel)

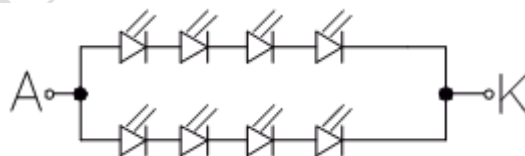

## 5 Timing Characteristics

### 5.1 Parallel 24-bit RGB Timing Table

Item	Symbol	Min.	Typ.	Max.	Unit	Remark
DCLK Frequency	Fclk	8	9	12	MHz	
DCLK Period	Tclk	83	111	125	ns	
Frame Pate	FR			75	Hz	
Line Period	Tlp	24			us	
HSYNC	Period Time	Th	531		DCLK	
	Display Period	Thdisp	480		DCLK	
	Back Porch	Thbp	43		DCLK	By H_Blanking setting
	Front Porch	Thfp	8		DCLK	
	Pulse Width	Thw	4		DCLK	
VSYNC	Period Time	Tv	292		H	
	Display Period	Tvdisp	272		H	
	Back Porch	Tvbp	12		H	By V_Blanking setting
	Front Porch	Tvfp	8		H	
	Pulse Width	Tvw	4		H	

### 5.2 SYNC Mode Timing Diagram

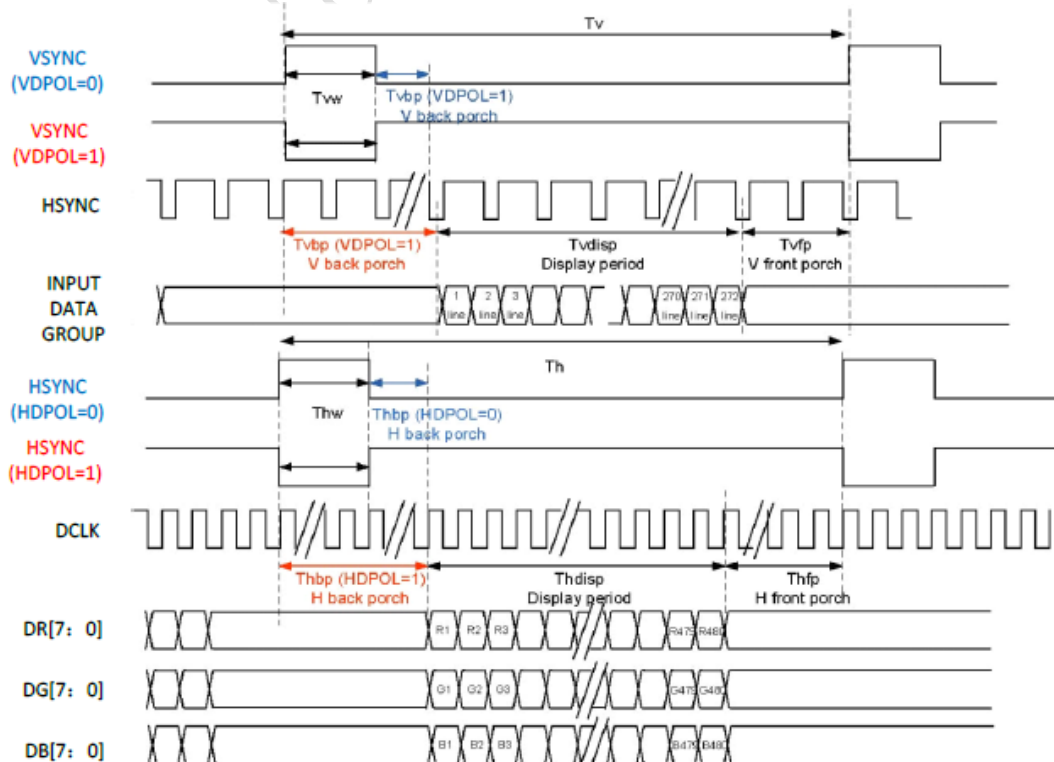



### 5.3 SYNC-DE Mode Timing Diagram

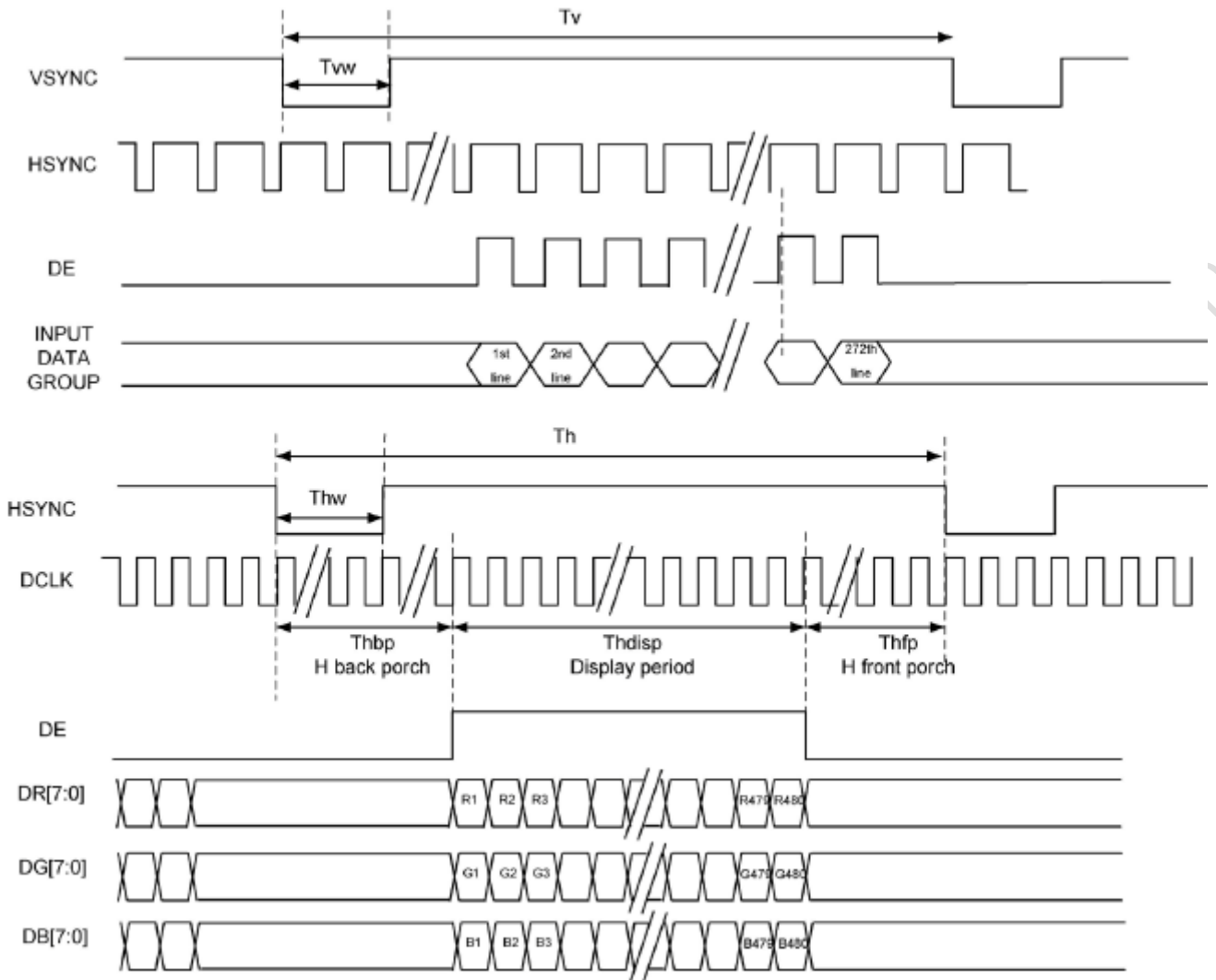

### 5.4 Power On/Off Sequence

#### 5.4.1 Power On Sequence

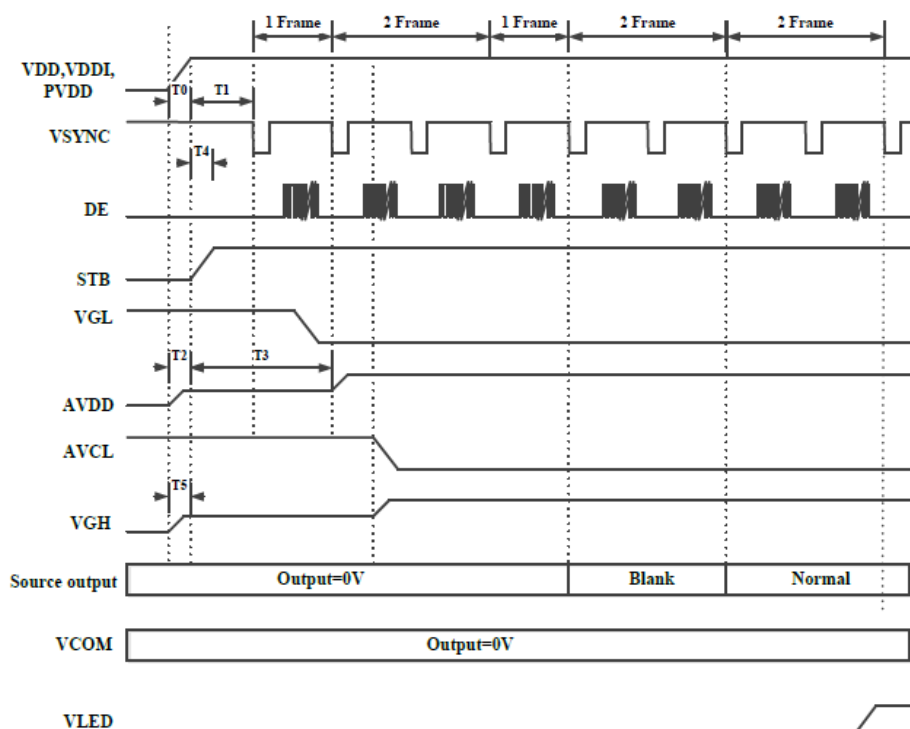

	Description	Min. Time
T0	Determined by the external power	
T1	Time from stable VDD, VDDI, PVDD set-up to the first VSYNC	T1=0
T2	Time from AVDD=0V to AVDD=3.3V	T2=T0
T3	Time from AVDD=3.3V to AVDD=6.0V	T3=T1+ (1*Frame)
T4	Time from stable VDD, VDDI, PVDD set-up to DISP asserted	T4=0
T5	Time from VGH=0V to VGH=3.3V	T5=T0

### 5.4.2 Power Off Sequence

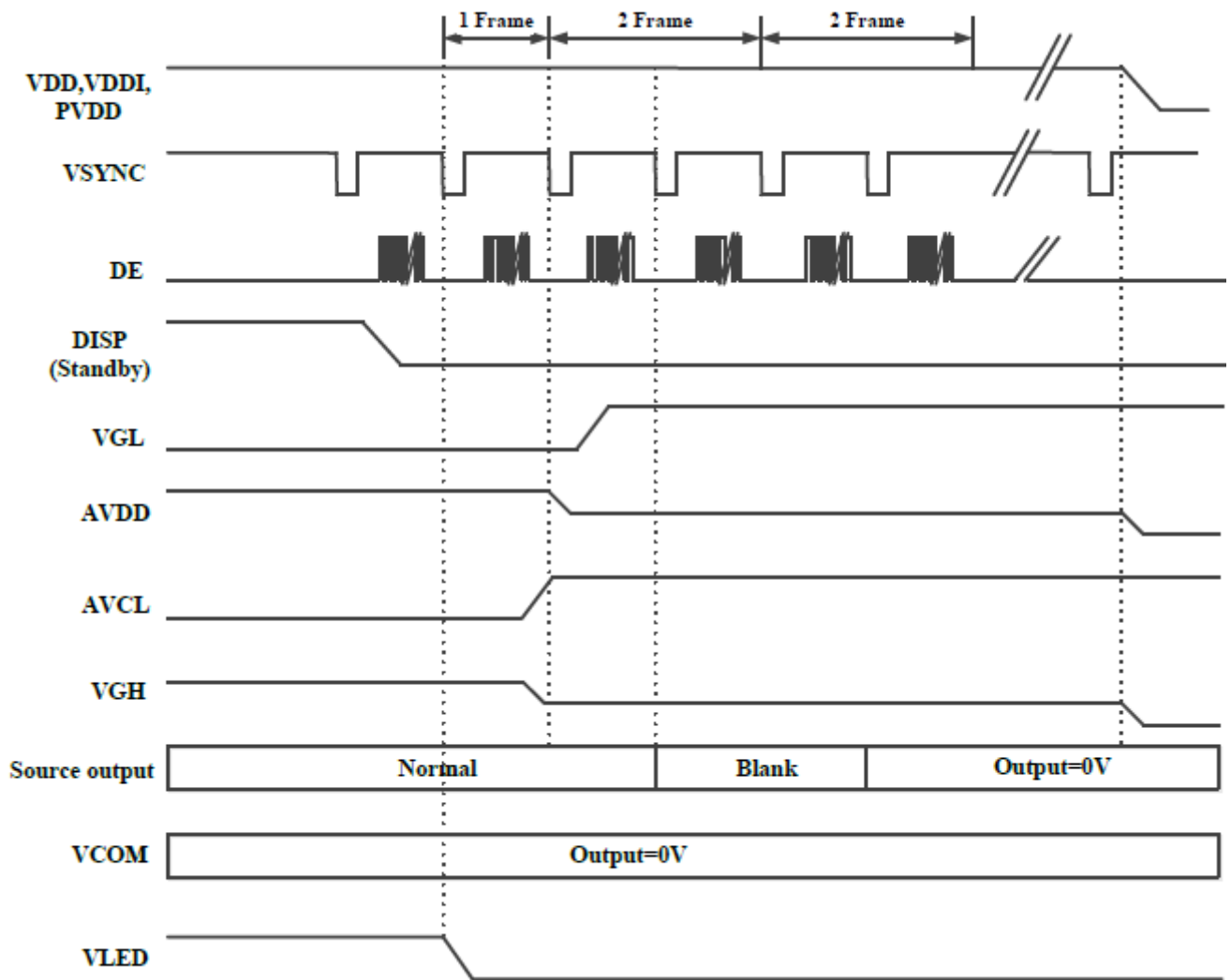

## 6 Optical Characteristics

Item	Symbol	Condition	Min.	Typ.	Max.	Unit	Remark
Viewing Angle	Top	$CR \geq 10$	-	50	-	Deg.	Note 2
	Bottom		-	70	-		
	Left		-	70	-		
	Right		-	70	-		
Contrast Ratio	CR	$\theta=0^\circ$	-	500	-		
Response Time	$T_r+T_f$	-	-	25	35	ms	Note 4
Color Chromaticity (CIE1931)	Wx	$\theta=0^\circ$	0.283	0.303	0.323		Note 5
	Wy		0.319	0.339	0.359		
	Rx		-	-	-		
	Ry		-	-	-		
	Gx		-	-	-		
	Gy		-	-	-		
	Bx		-	-	-		
	By		-	-	-		
Transmittance	Tr	-	(6.2)	(6.6)	-	%	

Test conditions:

IF= 40 mA, and the ambient temperature is 25°C.

**Note 1: Definition of optical measurement system.**

The optical characteristics should be measured in dark room. After 5 minutes operation, the optical properties are measured at the center point of LCD.

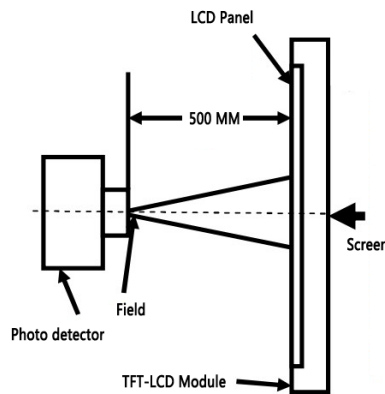

**Note 2: Definition of viewing angle range and measurement system.**

The viewing angle is measured at the center point of the LCD by BM-7A.

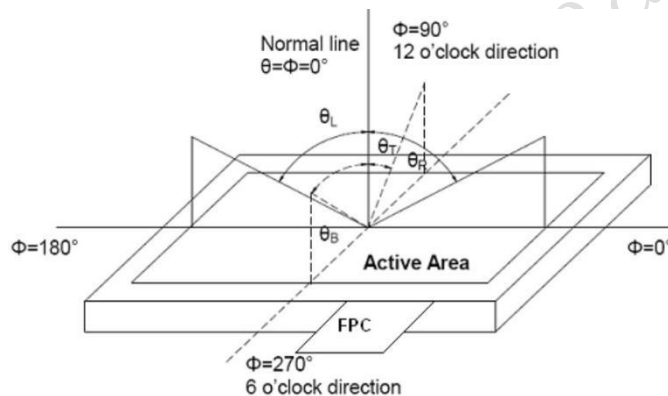

**Note 3: Definition of color temperature.**

When the radiation of the light source is exactly the same in the visible region and the absolute blackbody, the temperature of the blackbody is called the color temperature of the light source. Color temperature is an index to measure the degree of light source color (cold color, warm color). Warm color < 3300K, intermediate color 3300 ~ 5000K, cold color > 5000K

**Note 4: Definition of response time.**

The response time is defined as the LCD optical switching time interval between “White” state and “Black” state. Time ON (TON) is the time between photo detector output intensity changed from 90% to 10%. And time off (TOFF) is the time between photo detector output intensity changed from 10% to 90%.

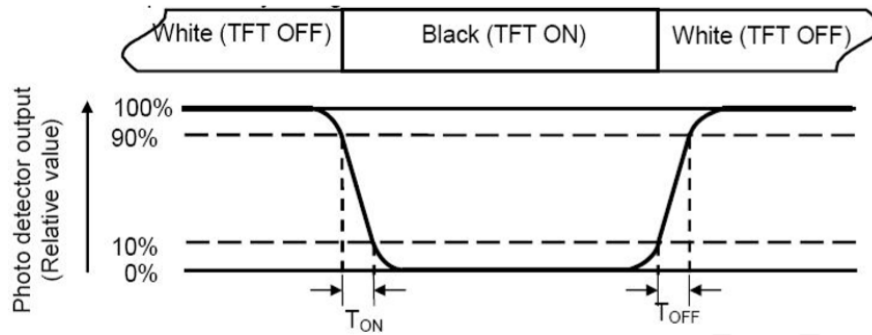
**Note 5: Definition of color chromaticity (CIE1931).**

Color coordinates measured at center point of LCD.

**Note 6: Definition of luminance.**

Measure the luminance of white state at center point.

## 7 Environmental Reliability Test

NO	Test Item	Condition	Remarks
1	High Temperature Operation	Ta=+70°C, 48hours	IEC60068-2-1:2007 GB2423.2-2008
2	Low Temperature Operation	Ta=-20°C, 48hours	IEC60068-2-1:2007 GB2423.1-2008
3	High Temperature Storage	Ta=+80°C, 48hours	IEC60068-2-1:2007 GB2423.2-2008
4	Low Temperature Storage	Ta=-30°C, 48hours	IEC60068-2-1:2007 GB2423.1-2008
5	Storage at High Temperature and Humidity	Ta=+60°C, 90% RH,48hours	IEC60068-2-78 :2001 GB/T2423.3-2006
6	Thermal Shock (non-operation)	-20°C /30min← →+70°C/30min, Change time:5min,10cycles	Start with cold temperature, End with high temperature, IEC60068-2-14:1984, GB 2423.22-2002
7	ESD(non-operation)	C=150pF, R=330Ω,5 point/panel Air: ±15Kv, 5 times; Contact:±8Kv, 5times (Environment:15°C~35°C, 30%~60%.86Kpa~106Kpa)	IEC61000-4-2:2001 GB/T 17626.2-2006

## 8 Packing Capacity & Dimension

Dimension			
Dimension(mm)	105.40(W)*67.10(H)*4.73(D)		
Net Weight	-		
Packing Capacity			
Size	LCD Size and Resolution	Layer	Quantity (Pcs)
220mm(L)x160mm(W)x47mm(H)	4.3 inch 480*272	1	1
600mm(L)x450mm(W)x300mm(H)	4.3 inch 480*272	2	240

Packing instruction:

The LCD+TP is placed in the grid, covered with a PE static bag and compactly assembled, the upper and the lower layers of the grid are protected by buffer spaces.

The LCD covered with a PE static bag and compactly assembled



placed in the grid



The upper and the lower layers of the grid are protected by buffer spaces



Packed



## 9 Appearance Inspection

### 9.1 General rules for inspection

9.1.1 Anti-static wearables (anti-static wristbands, gloves) must be worn during the inspection.

9.1.2 Do not use bare hands to touch the position of the device, golden fingers, and the surface of the screen to prevent the sweat from human hands from causing oxidation and affecting the appearance.

9.1.3 It is forbidden to stack products out of specification and handle them with care to avoid damage to components.

9.1.4 The repaired products need to be inspected to prevent rosin and tin slag from exceeding the specifications.

9.1.5 When technical documents and process documents have specific requirements for products, the technical documents and process documents shall be the main requirements.

### 9.2 Inspection conditions

9.2.1 The conditions of display function check

Angle:  $\pm 5^\circ$ ;

Inspection method: visual inspection. The inspection object is 30-40cm away from the light source, and the eye is 30-40cm away from the inspection object;

Illumination: 300-500Lux;

Inspection time: 5-10S.

9.2.2 Visual inspection conditions

Angle:  $\pm 45^\circ$ ;

Inspection method: visual inspection. The inspection object is 30-40cm away from the light source, and the eye is 30-40cm away from the inspection object;

Illumination: 800-1500Lux;

Inspection time: 5-10S.

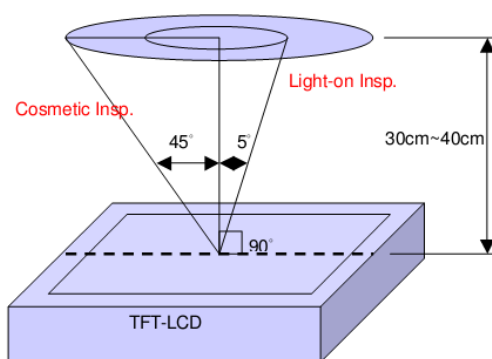

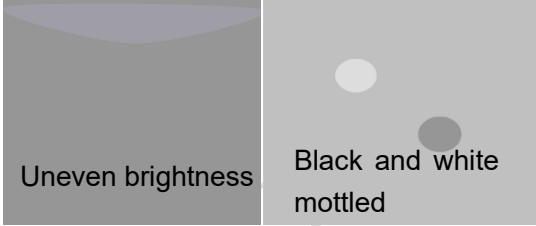
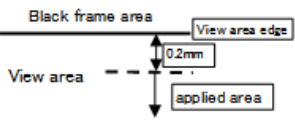

## 9.3 Inspection standard

Type	Test Items	Judgement Standard	Defect Category
Display state	Dead pixels	No dead pixels	
	mura	From different angles, the brightness is required to be uniform. Under the 64-level grayscale or pure black interface, there should be no uneven display brightness within the viewing angle range of 45° through 6% ND FILTER. Y series (TV film) LCD screen does not have specific requirements, and the picture inspection does not affect the display as qualified.	Slight defect
			
	Light leakage	Under the 64-level grayscale or pure black interface, there should be no obvious light leakage within the viewing angle range of 45° by visual inspection or through 6% ND FILTER. Y series (TV LCD screen) series can be without obvious visual defects.	Slight defect
	Linear foreign bodies	1. $W \leq 0.05$ , $L \leq 2$ mm, negligible; 2. $0.05\text{mm} < W \leq 0.1\text{mm}$ , $L \leq 2$ mm, $N \leq 3$ ; 3. $W > 0.1\text{mm}$ , $L > 2$ mm, not allowed.	Slight defect
	Bubble in OCA	1. $D < 0.20$ mm, negligible; 2. $0.20\text{mm} < D \leq 0.30\text{mm}$ , $N \leq 4$ and, $DS > 10$ mm; 3. $0.30\text{mm} < D \leq 0.35\text{mm}$ , $N \leq 3$ and, $DS > 10$ mm; 4. $0.35\text{mm} < D$ , fault. (Guarantee area: within 0.2mm outside VA)	
Screen surface	Within the effective area	Spotted: 1. $D \leq 0.2$ mm and it is not a piece, it is not counted; 2. $0.2\text{mm} < D \leq 0.5\text{mm}$ , $N \leq 3$ ; 3. $D > 0.5\text{mm}$ , $L > 0.5\text{mm}$ , $W > 0.5\text{mm}$ are not allowed; (The spotted foreign objects shall not exceed the point-line gauge $D=0.5$ , and the black dot coverage shall be checked, and the spotted foreign objects shall be judged within the range of $D=0.5$ )	Slight defect
		Linear: 1. $W \leq 0.05$ , $L \leq 2$ mm, ignored; 2. $0.05 < W \leq 0.1\text{mm}$ , $L \leq 2$ mm, $N \leq 3$ ; 3. $W > 0.1\text{mm}$ , $L > 2$ mm, not allowed.	
	Outside the effective area Foreign objects Scratches Air bubbles	Foreign objects are not checked, and bubbles are not allowed to $D > 1$ mm; Non-inductive scratches of no more than $0.1 \times 8$ mm are allowed.	Slight defect

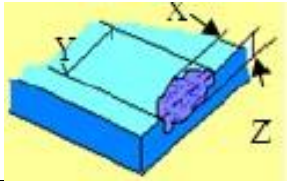
	Crack	Not allowed.		Slight defect
	Notch	1. Does not affect the appearance from the front; 2. Does not affect the relevant alignment; 3. $X \leq 1\text{mm}$ , $Y \leq 1\text{mm}$ , $N \leq 2$ .		Slight defect
	Glass side Foreign objects Dirty	1. The foreign body on the side is not controlled; 2. The paint pen marks on the side are not controlled; 3. Side oily note printing is not allowed.		Slight defect
FPC	Cracks Goldfinger crease	Not allowed.		Heavy deficit
	Crease	Slight creases are not controlled; The crease is whitish and has lines, which is not allowed.		Heavy deficit
	Top wound, stab wound	No damage to the line, $D \leq 0.2\text{mm}$ ; Damage to the line is not allowed.		Heavy deficit
	Scratch	Slight scratches on the surface are not controlled; Damage to the line is not allowed.		Heavy deficit
	Goldfinger scratch	$W \leq 0.05\text{mm}$ , no control; $W > 0.05\text{mm}$ , not allowed; Test probe tip marks are not controlled.		Heavy deficit
	Component	Under-soldering, over-soldering and false soldering are not allowed.		Heavy deficit

## 10 Precautions for Use of LCD Modules

### 10.1 Handling Precautions

10.1.1 The display panel is made of glass. Do not subject it to a mechanical shock by dropping it from a high place, etc.

10.1.2 If the display panel is damaged and the liquid crystal substance inside it leaks out, be sure not to get any in your mouth, if the substance comes into contact with your skin or clothes, promptly wash it off using soap and water.

10.1.3 Do not apply excessive force to the display surface or the adjoining areas since this may cause the color tone to vary.

10.1.4 The polarizer covering the display surface of the LCD module is soft and easily scratched. Handle this polarizer carefully.

10.1.5 If the display surface is contaminated, breathe on the surface and gently wipe it with a soft dry cloth. If still not completely clear, Can only use LCD dedicated cleaner, the following organic solvent can not be used:

- Isopropyl alcohol
- Ethyl alcohol
- Ketone
- Aromatic solvents

10.1.6 Do not attempt to disassemble the LCD Module.

10.1.7 If the logic circuit power is off, do not apply the input signals.

10.1.8 To prevent destruction of the elements by static electricity, be careful to maintain an

10.1.9 optimum work environment.

10.1.9.1 Be sure to ground the body when handling the LCD Modules.

10.1.9.2 Tools required for assembly, such as soldering irons, must be properly ground.

10.1.9.3 To reduce the amount of static electricity generated, do not conduct assembly and other work under dry conditions.

10.1.9.4 The LCD Module is coated with a film to protect the display surface. Be care when peeling off this protective film since static electricity may be generated.

### 10.2 Storage precautions

10.2.1 When storing the LCD modules, avoid exposure to direct sunlight or to the light of fluorescent lamps.

10.2.2 The LCD modules should be stored under the storage temperature range. If the LCD modules will be stored for a long time, the recommend condition is:

Temperature: 0°C ~ 40°C Relatively humidity: ≤80%.

10.2.3 The LCD modules should be stored in the room without acid, alkali and harmful gas.

### 10.3 Transportation Precautions

10.3.1 The LCD modules should be no falling and violent shocking during transportation, and also should avoid excessive press, water, damp and sunshine.

## 11 Laminated Screen Introduction

DWIN adopts original class A glass and the entire production is in the park from cleaning, cutting, bonding, and laminating of large glass to backlight assembly, quality inspection, and aging.

There are 12,000 square meters of clean workshop, with a monthly production capacity of about 2.5 million pieces. Each piece of LCD produced in the factory is for 30 days of aging.

### 11.1 Laminated screen classification

The laminated screen is mainly composed of cover glass, TP and LCD. The lamination methods can be either frame lamination or full lamination. The frame lamination process fixes TP with the four sides of LCD by 3M adhesive, which is one of the most common lamination methods. Full lamination is to seamlessly bond LCD and TP by optical adhesive. Compared to frame lamination, full lamination features by moisture-proof, dust-proof, high stability, high quality display, and can achieve the visible display under strong light.

### 11.2 ODM service

DWIN technology has built the Huan DWIN Science Park with a construction area of 250000 square meters (In addition, another 148000 square meters are under construction), integrating industrial chain of LCM, SMT, CTP, RTP, mold injection, and Sheet metal punching. DWIN can guarantee the production of LCM, CTP and RTP with first-class technology, highly automated and intelligent manufacturing equipment.

The production capacity of LCM lines is 2.5 million. The LCM lines support the production of LCM with high luminance(1200 nit), wide operating temperature(-40~85°C), anti-electromagnetic interference, sunlight readability and HDMI interface .

The production capacity of RTP lines is 5 hundred thousand. The RTP lines support the production of customized 4-wire RTP and 5-wire RTP, anti-UV material and AG material.

The production capacity of CTP lines is 1 million. The CTP lines support the production of customized CTP, including 1.3~21.5 inches (unconventional size), circular CTP, the shape, color and logo of cover plate, anti-UV, anti- fingerprint and AG material. They can also support the customization of various kinds of technologies, such as OCA lamination, ultrathin GFF, optical bonding, 2.5D and sunlight readability.

SMT lines



CTP lines



LCM lines



RTP lines



Final inspection lines



IQC lines



Laboratories



## Record of Revision

Rev	Date	Description	Editor
00	2023-03-08	First Release	Chen
01	2023-04-26	Update CAD	Chen
02	2023-05-11	Update Terminals	Chen

Please contact us if you have any questions about the use of this document or our products, or if you would like to know the latest information about our products:

Customer service tel: +86 400 018 9008

Customer service email: [dwinhmi@dwin.com.cn](mailto:dwinhmi@dwin.com.cn)

DWIN developer forum: <https://forums.dwin-global.com/index.php/forums/>

Thank you all for continuous support of DWIN, and your approval is the driving force of our progress!