

### Features:

- 1200V NPT Trench Technology
- High Speed Switching
- Low Conduction Loss
- Positive Temperature Coefficient
- Easy parallel Operation
- RoHS compliant
- JEDEC Qualification

### Applications :

Induction Heating, Soft switching application

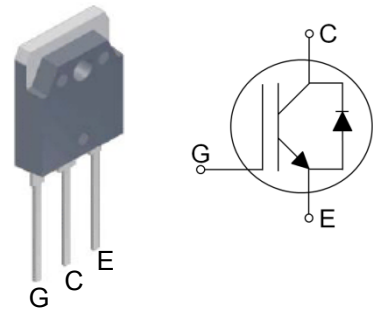

Device	Package	Marking	Remark
TGAN25N120ND	TO-3PN	TGAN25N120ND	RoHS

### Absolute Maximum Ratings

Parameter	Symbol	Value	Unit
Collector-Emitter Voltage	$V_{CES}$	1200	V
Gate-Emitter Voltage	$V_{GES}$	$\pm 20$	V
Continuous Collector Current	$I_c$	$T_C = 25\text{ }^\circ\text{C}$	50
		$T_C = 100\text{ }^\circ\text{C}$	25
Pulsed Collector Current (Note 1)	$I_{CM}$	75	A
Diode Continuous Forward Current	$I_F$	25	A
Diode Maximum Forward Current	$I_{FM}$	75	A
Power Dissipation	$P_D$	$T_C = 25\text{ }^\circ\text{C}$	312
		$T_C = 100\text{ }^\circ\text{C}$	125
Operating Junction Temperature	$T_J$	-55 ~ 150	$^\circ\text{C}$
Storage Temperature Range	$T_{STG}$	-55 ~ 150	$^\circ\text{C}$
Maximum lead temperature for soldering purposes, 1/8" from case for 5 seconds	$T_L$	300	$^\circ\text{C}$

Notes :

(1) Repetitive rating : Pulse width limited by maximum junction temperature

### Thermal Characteristics

Parameter	Symbol	Value	Unit
Maximum Thermal resistance, Junction-to-Case	$R_{\theta JC}$ (IGBT)	0.4	$^\circ\text{C}/\text{W}$
Maximum Thermal resistance, Junction-to-Case	$R_{\theta JC}$ (DIODE)	2.1	$^\circ\text{C}/\text{W}$
Maximum Thermal resistance, Junction-to-Ambient	$R_{\theta JA}$	40	$^\circ\text{C}/\text{W}$

**Electrical Characteristics of the IGBT**  $T_C=25^\circ\text{C}$ , unless otherwise noted

Parameter	Symbol	Test condition	Min.	Typ.	Max.	Unit
<b>OFF</b>						
Collector – Emitter Breakdown Voltage	$BV_{CES}$	$V_{GE} = 0V, I_C = 1mA$	1200	--	--	V
Zero Gate Voltage Collector Current	$I_{CES}$	$V_{CE} = 1200V, V_{GE} = 0V$	--	--	1	mA
Gate – Emitter Leakage Current	$I_{GES}$	$V_{CE} = 0V, V_{GE} = \pm 20V$	--	--	$\pm 250$	nA
<b>ON</b>						
Gate – Emitter Threshold Voltage	$V_{GE(TH)}$	$V_{GE} = V_{CE}, I_C = 25mA$	3.0	5.0	7.0	V
Collector – Emitter Saturation Voltage	$V_{CE(SAT)}$	$V_{GE} = 15V, I_C = 25A, T_C = 25^\circ\text{C}$	--	1.9	2.5	V
		$V_{GE} = 15V, I_C = 25A, T_C = 125^\circ\text{C}$	--	2.2	--	V
<b>DYNAMIC</b>						
Input Capacitance	$C_{IES}$	$V_{CE} = 30V,$ $V_{GE} = 0V$ $f = 1MHz$	--	4000	--	pF
Output Capacitance	$C_{OES}$		--	105	--	pF
Reverse Transfer Capacitance	$C_{RES}$		--	72	--	pF
<b>SWITCHING</b> (Note 2)						
Turn-On Delay Time	$t_{d(on)}$	$V_{CC} = 600V, I_C = 25A$ $R_G = 10\Omega, V_{GE} = 15V$ Inductive Load, $T_C = 25^\circ\text{C}$	--	57	--	ns
Rise Time	$t_r$		--	65	--	ns
Turn-Off Delay Time	$t_{d(off)}$		--	240	--	ns
Fall Time	$t_f$		--	86	160	ns
Turn-On Switching Loss	$E_{ON}$		--	4.15	6.22	mJ
Turn-Off Switching Loss	$E_{OFF}$		--	0.87	1.31	mJ
Total Switching Loss	$E_{TS}$		--	5.02	7.53	mJ
Turn-On Delay Time	$t_{d(on)}$	$V_{CC} = 600V, I_C = 25A$ $R_G = 10\Omega, V_{GE} = 15V$ Inductive Load, $T_C = 125^\circ\text{C}$	--	41	--	ns
Rise Time	$t_r$		--	57	--	ns
Turn-Off Delay Time	$t_{d(off)}$		--	265	--	ns
Fall Time	$t_f$		--	168	--	ns
Turn-On Switching Loss	$E_{ON}$		--	4.46	6.69	mJ
Turn-Off Switching Loss	$E_{OFF}$		--	1.74	2.61	mJ
Total Switching Loss	$E_{TS}$		--	6.2	9.30	mJ
Total Gate Charge	$Q_g$	$V_{CC} = 600V, I_C = 25A$ $V_{GE} = 15V$	--	230	350	nC
Gate-Emitter Charge	$Q_{ge}$		--	25	40	nC
Gate-Collector Charge	$Q_{gc}$		--	70	100	nC

Notes :

(2) Not subject to production test – verified by design/characterization

**Electrical Characteristics of the DIODE  $T_C=25^\circ\text{C}$ , unless otherwise noted**

Parameter	Symbol	Test condition		Min.	Typ.	Max.	Unit
Diode Forward Voltage	$V_{FM}$	$I_F = 25\text{A}$	$T_C = 25^\circ\text{C}$	--	2.0	2.5	V
			$T_C = 125^\circ\text{C}$	--	2.18	--	
Reverse Recovery Time	$t_{rr}$	$I_F = 25\text{A},$ $di/dt = 200\text{A}/\mu\text{s}$	$T_C = 25^\circ\text{C}$	--	300	480	ns
			$T_C = 125^\circ\text{C}$	--	360	--	
Reverse Recovery Current	$I_{rr}$		$T_C = 25^\circ\text{C}$	--	27	41	A
			$T_C = 125^\circ\text{C}$	--	31	--	
Reverse Recovery Charge	$Q_{rr}$		$T_C = 25^\circ\text{C}$	--	4000	--	nC
			$T_C = 125^\circ\text{C}$	--	5580	--	

# IGBT Characteristics

Fig. 1 Output characteristics

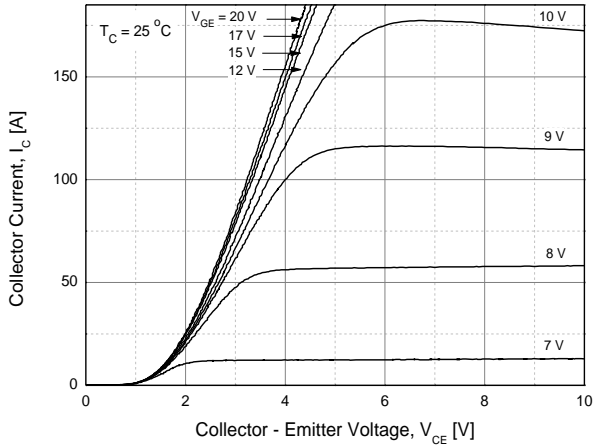

Fig. 2 Saturation voltage characteristics

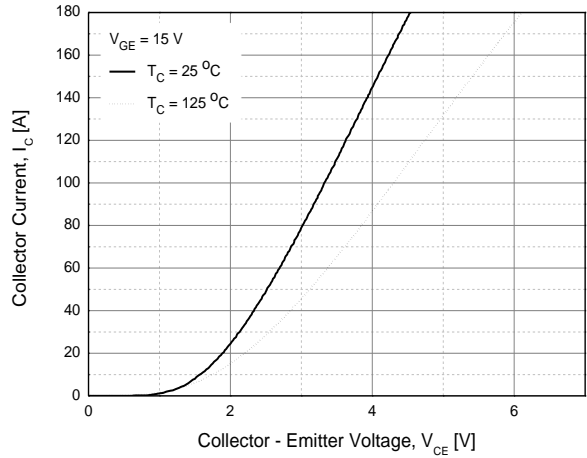

Fig. 3 Saturation voltage vs. collector current

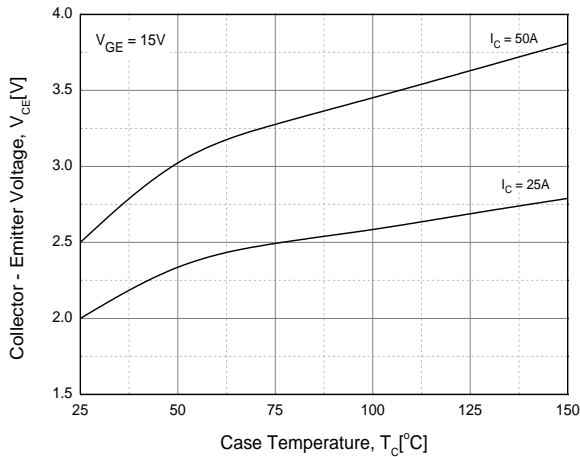

Fig. 4 Saturation voltage vs. gate bias

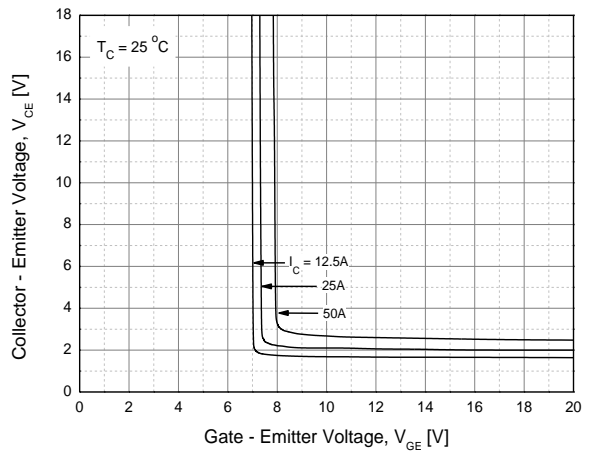

Fig. 5 Saturation voltage vs. gate bias

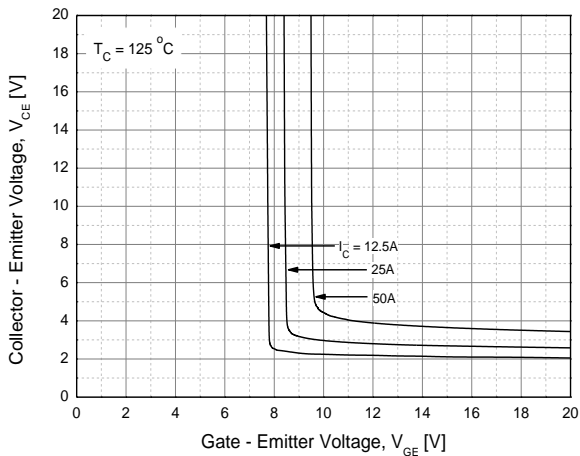
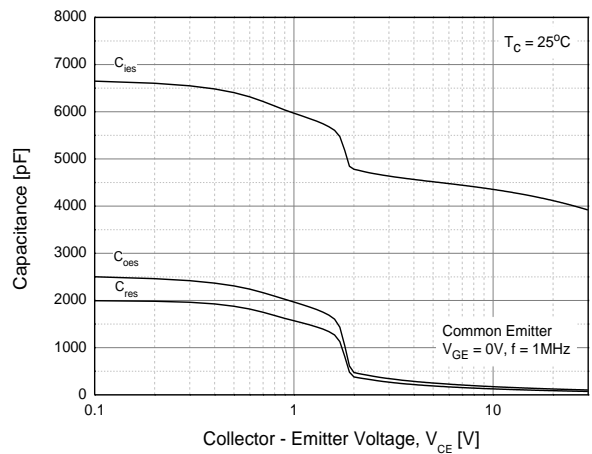

Fig. 6 Capacitance characteristics



## IGBT Characteristics

Fig. 7 Turn-on time vs. gate resistor

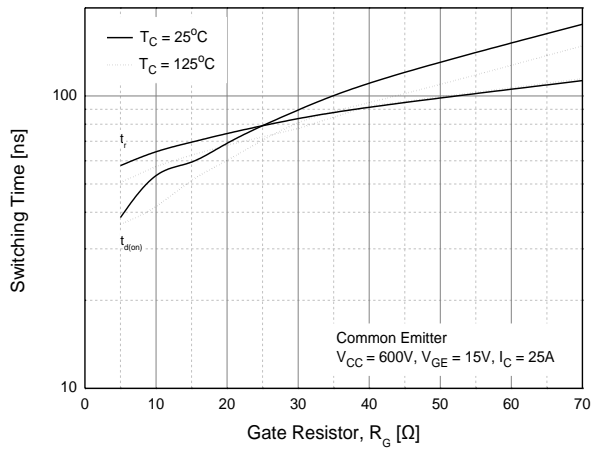

Fig. 8 Turn-off time vs. gate resistor

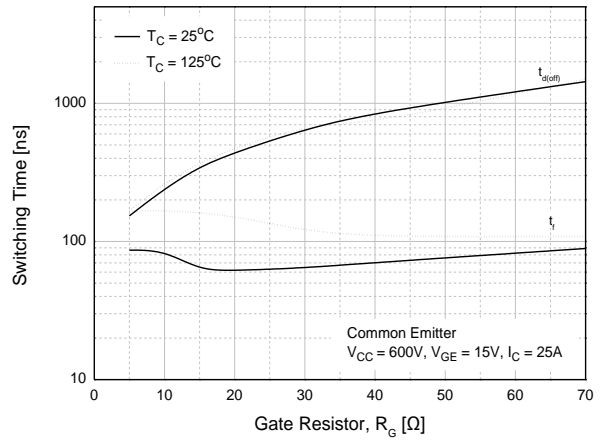

Fig. 9 Switching loss vs. gate resistor

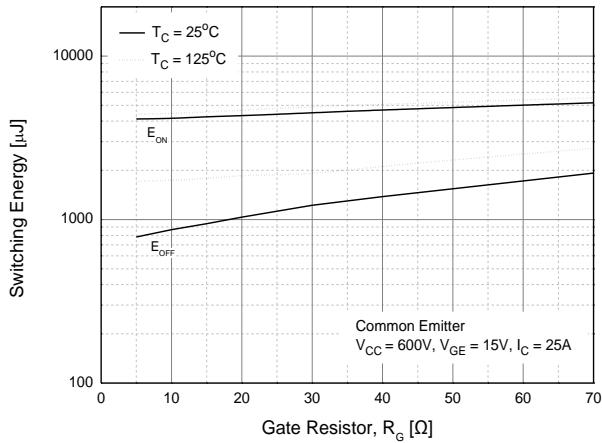

Fig. 10 Turn-on time vs. collector current

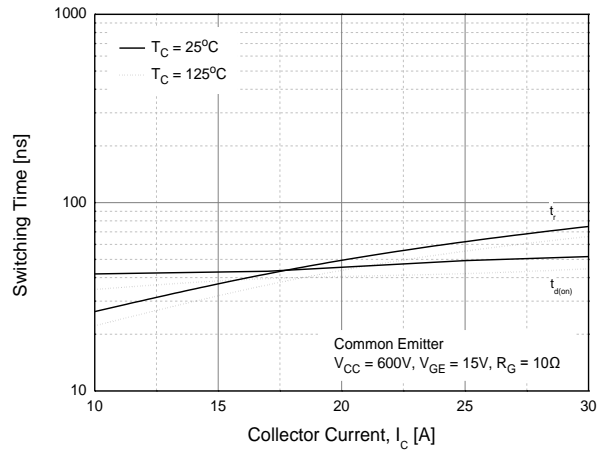

Fig. 11 Turn-off time vs. collector current

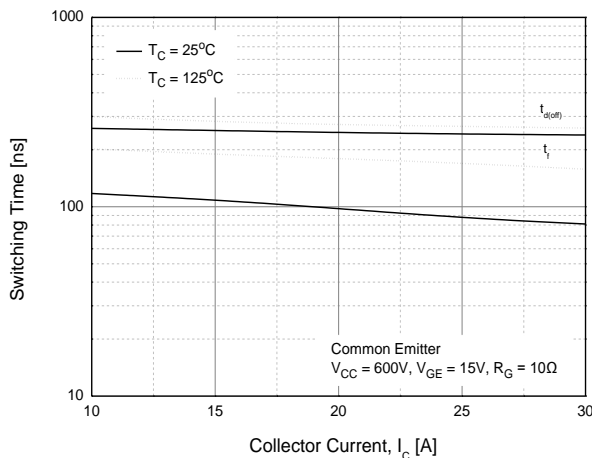
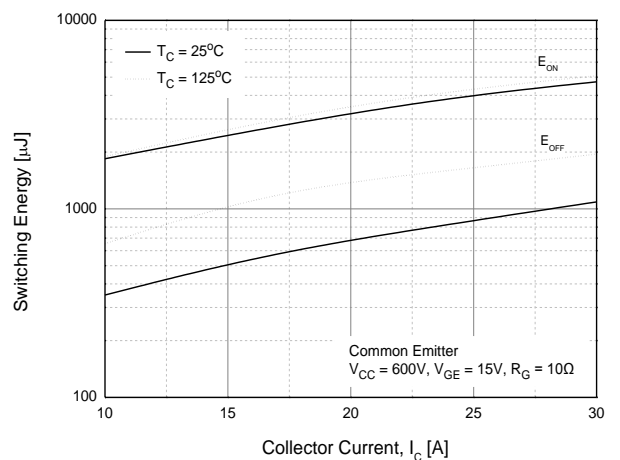

Fig. 12 Switching loss vs. collector current



## IGBT Characteristics

Fig. 13 Gate charge characteristics

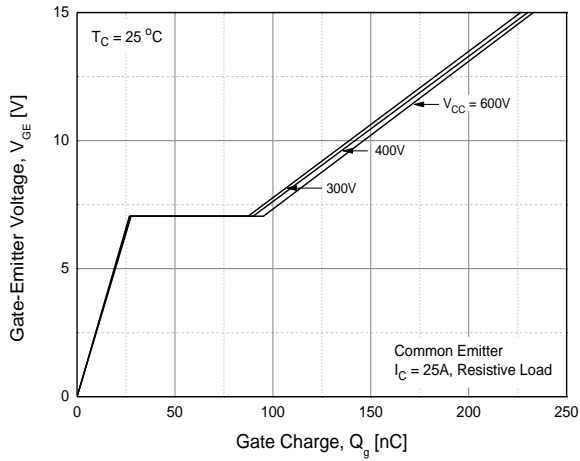

Fig. 14 SOA

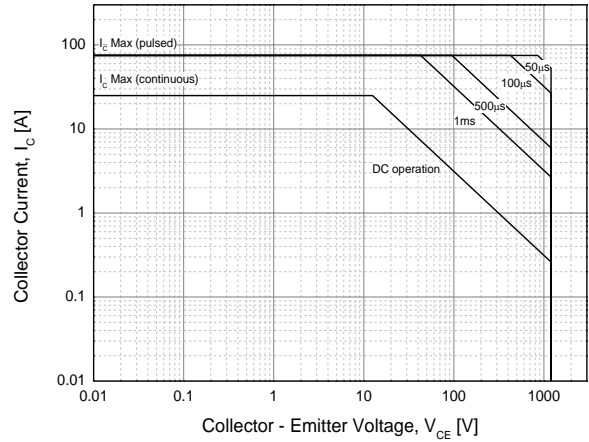

Fig. 15 RBSOA

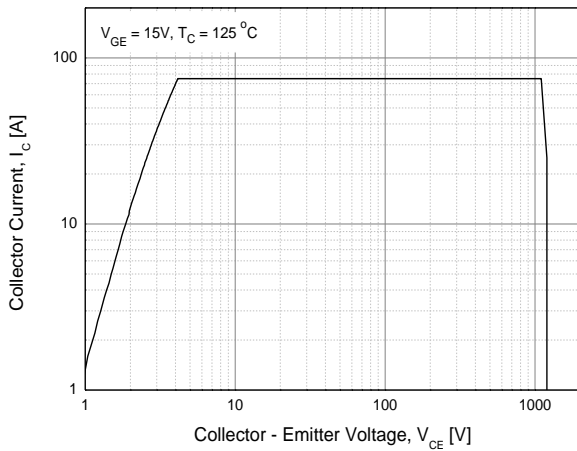

Fig. 16 Transient thermal impedance of IGBT

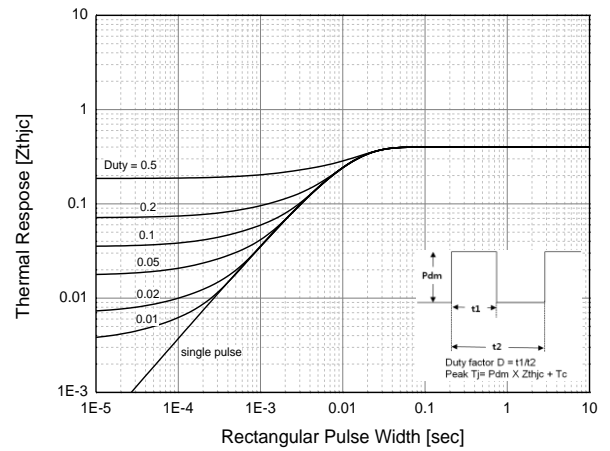
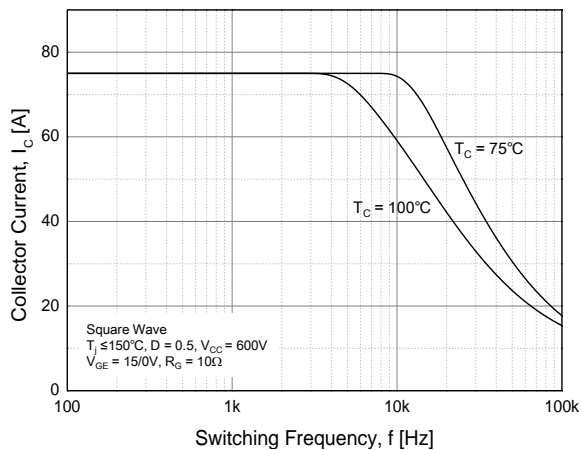

Fig. 17 Load Current vs. Frequency



## Diode Characteristics

Fig. 18 Conduction characteristics

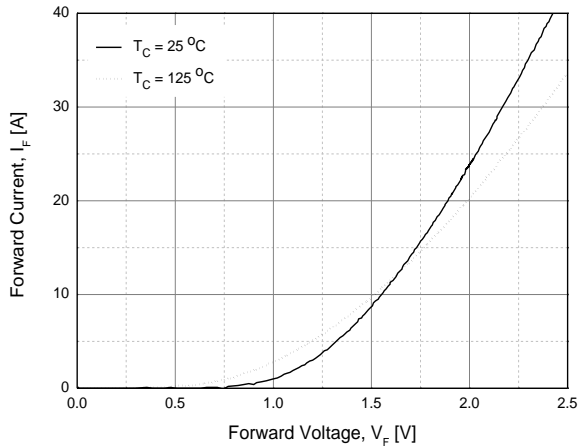

Fig. 19 Reverse recovery current vs. forward current

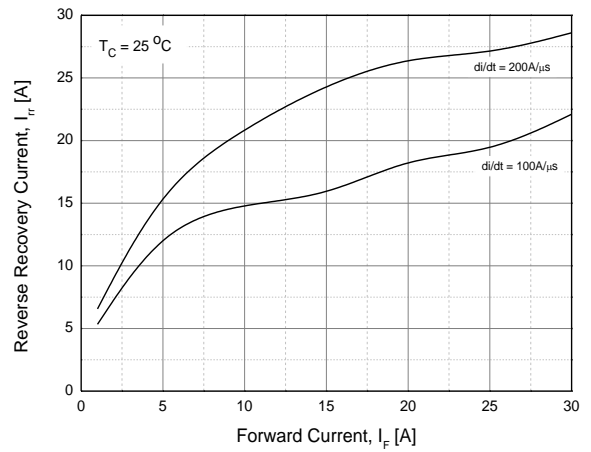

Fig. 20 Reverse recovery charge vs. forward current

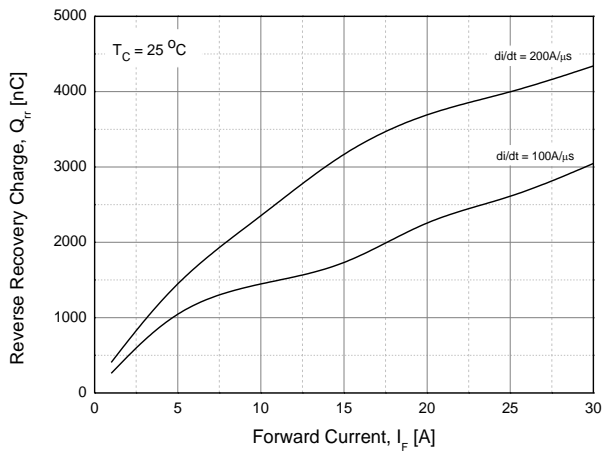
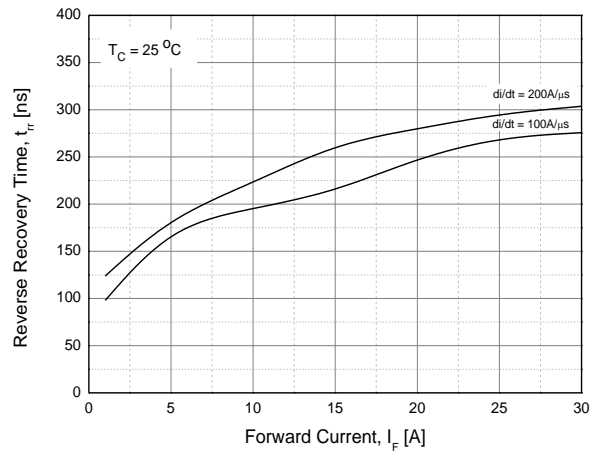
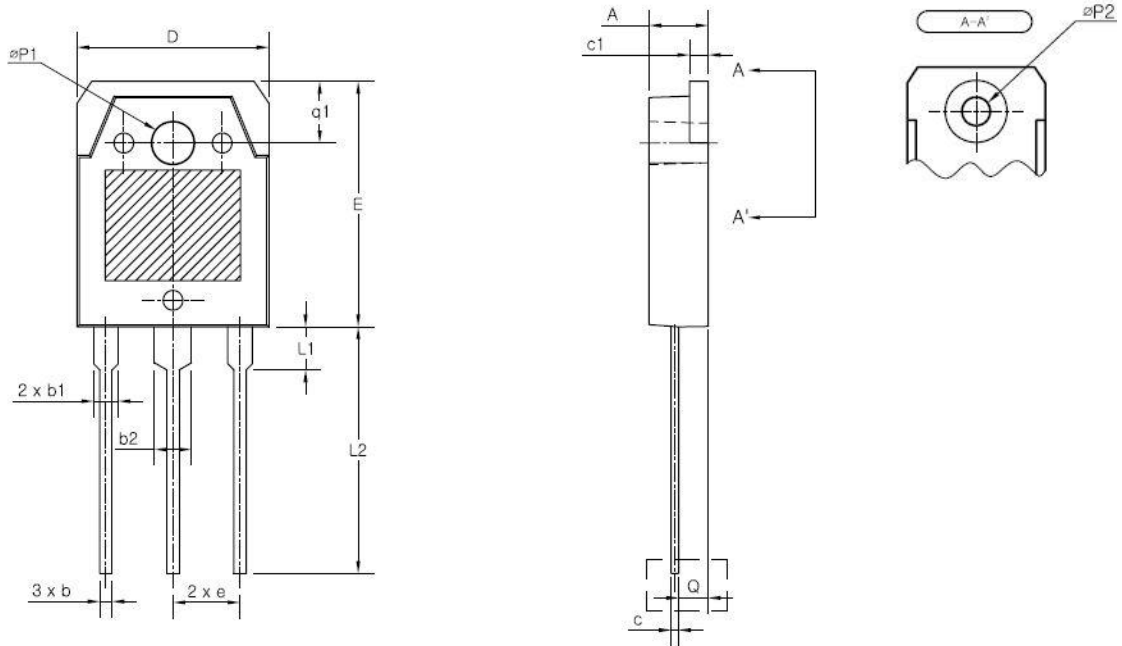

Fig. 21 Reverse recovery time vs. forward current



**TO-3PN MECHANICAL DATA**



SYMBOL	MIN	NOM	MAX
A	4.60	4.80	5.00
b	0.80	1.00	1.20
b1	1.80	2.00	2.20
b2	2.80	3.00	3.20
c	0.55	0.60	0.75
c1	1.45	1.50	1.65
D	15.40	15.60	15.80
E	19.70	19.90	20.10
e	5.15	5.45	5.75
L1	3.30	3.50	3.70
L2	19.80	20.00	20.20
øP1	3.30	3.40	3.50
øP2	(3.20)		
Q	2.20	2.40	2.60
q1	4.80	5.00	5.20

**Disclaimer**

TRinno technology reserves the right to make changes without notice to products herein to improve reliability, performance, or design. The information given in this document is believed to be accurate and reliable. However, it shall in no event be regarded as a guarantee of conditions and characteristics. With respect to any information regarding the application of the device, TRinno technology hereby disclaims any and all warranties and liabilities of any kind, including without limitation, warranties of non-infringement of patent rights of any third party.